

morettini[®]

morettini[®]



catalogo catalogue 14
maniglie e accessori d'arredo
door handles and accessories



La ditta Morettini, operante da oltre 50 anni sul mercato italiano ed internazionale con la sua produzione di maniglie e coordinati in ottone, ha continuato ad evolversi con esperienza e serietà verso la continua ricerca della massima qualità e varietà dei suoi prodotti.













Pur rimanendo legata alla tradizione artigianale, non ha trascurato le innovazioni tecnologiche in continua trasformazione: questo a garanzia della qualità dei suoi prodotti.

In linea con la sua filosofia, che l'ha contraddistinta in questi anni, con l'ausilio di esperti grafici ha studiato questo catalogo, che intende presentare alla sua affezionata clientela.

The Morettini company, active for more than 50 years in Italian and international markets, with its production of handles and brass accessories, has continued to evolve through experience and seriousness towards the continual search for maximum quality and variety in its products.

This company has remained tied to its craft tradition but has not overlooked the continual transformation of technological innovations: this guarantees the quality of its products.

In line with the philosophy which has differentiated this company over the years, this catalogue has been studied together with expert graphic designers for its valued customers.

	maniglie per porta door handles	03
	cerniere hinges	67
	accessori per porte scorrevoli accessories for sliding doors	75
	battenti door knockers	95
	maniglioni pull handles	101
	accessori per mobili accessories for furnitures	115
	gancetti small hooks	139
	pomoli door knobs	149
	complementi d'arredo accessories	155
	supporti supports	159
	catenacci bolts	165
	accessori vari accessories	173

FINITURE



OLV:
Ottone Lucido Verniciato



B/ANT:
Ottone Bronzo Antico



OBG:
Ottone Bronzo Graffiato



BR.YEST:
Ottone Bronzo Graffiato Verniciato Opaco



OCR:
Ottone Cromo Lucido



OCR/OCS:
Ottone Cromo Lucido/Cromo Satinato



OCS:
Ottone Cromo Satinato



OLV/OSV:
Ottone Lucido Verniciato/Ottone Satinato



NKS:
Ottone Nichel Satinato



OBV:
Bronzo Verniciato



B/INV:
Ottone Bronzo Invecchiato



FUMÉ:
Ottone Sfumato



quasar/quasar-r	4	magda	34
athena/atlanta	5	medea	35
galatea/galatea-r	6	medea-r	36
mizar/astrid	7	domus-r	37
diamante	8	moon/ludmilla	38
colt	9	marea	39
colt-r	10	cloè	40
elegant/elegant-r	11	vela	41
yvonne/kristina/ginevra	12	viola	42
esedra/elektra	13	helen	43
zaira/zaira-r	14	antea	44
golf	15	export	45
siena	16	époque	46
linz	17	merano	47
augustea	18	toscana	48
venere	19	altwien	49
viper	20	pinzolo	50
artesia	21	camelia	51
azzurra	22	rosa	52
brixia	23	ginestra	53
sabina	24	ninfea	54
sabina-r	25	margot	55
aurea	26	uovo	56
asia	27	gamma	57
demetra	28	liscia	58
daphne	29	mirage/astral	59
aster	30	barocco/rosella-m	60
amalfi	31	serie acciaio	61
europa	32	set pvc	64
tekno	33	accessori per blindati	63

maniglie per porta
door handles



KETTY
art. 2611

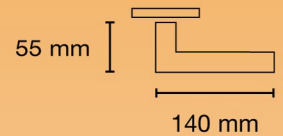

LIGHT
art. 2621

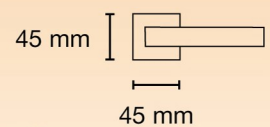
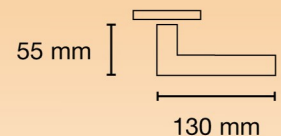

Prezzi in € - Price in €

ART.	KETTY DESCRIZIONE	CONF. PEZZI	Z/CS
2611	Coppia di maniglia c/rosetta tonda Ø50 mm e bocchetta a pressione <i>Handle on rose, square mm 50x50 with escutcheon</i>	02	31,40
2613	Martellina dry keep q. 7 c/ros. ovale movimento a 4 scatti <i>Window handles dry keep with mechanism 4 clicks</i>	04	19,90

Prezzi in € - Price in €

ART.	LIGHT DESCRIZIONE	CONF. PEZZI	Z/CS
2621	Coppia di maniglia c/rosetta quadrata mm 45x45 coprivite a pressione e bocchetta foro chiave <i>Handle on rose, square mm 45x45 with escutcheon</i>	02	27,40
2623	Martellina dry keep q. 7 c/ros. rettangolare movimento a 4 scatti <i>Window handles dry keep with mechanism 4 clicks</i>	04	18,80



PRODUZIONE MANIGLIE E ACCESSORI D'ARREDO
HANDLES AND ACCESSORIES PRODUCTION

Via del Sardano, 16 I 25070 PRESEGLIE (Brescia - Italy)
Tel. +39 0365 860245 I Fax +39 0365 1900092 I info@morettinimaniglie.com I morettinimaniglie@pec.it
www.morettinimaniglie.com



LASER
art. 2651

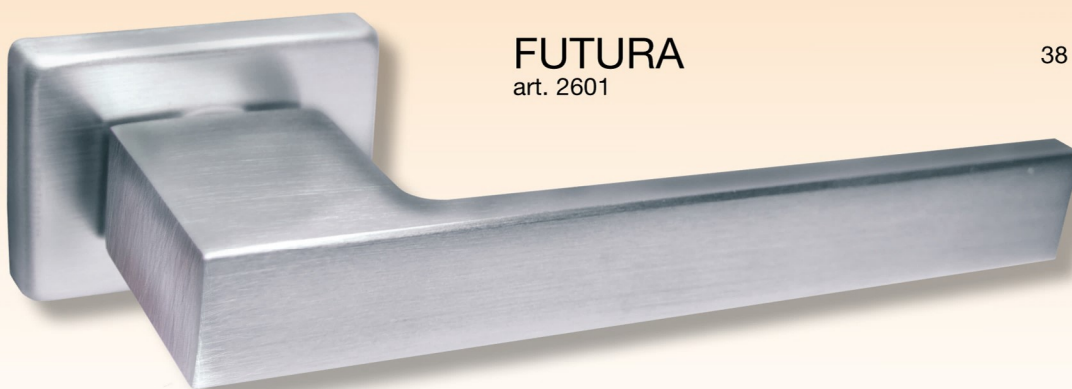
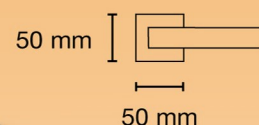
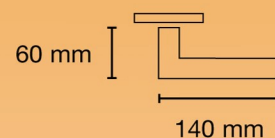

FUTURA
art. 2601

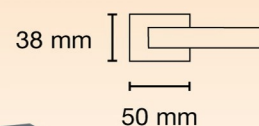
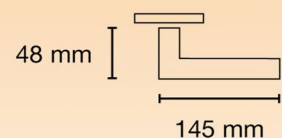

Prezzi in € - Price in €

ART.	LASER DESCRIZIONE	CONF. PEZZI	Z/CS
2651	Maniglia c/rosetta tonda Ø50 mm e bocchetta a pressione <i>Handle on rose, round Ø50 to screw with escutcheon</i>	02	31,50
2652	Maniglia c/rosetta quadrata mm 50x50 e bocchetta a pressione <i>Handle on rose, square mm 50x50 with escutcheon</i>	02	35,90
2653	Martellina dry keep q. 7 c/ros. ovale movimento a 4 scatti <i>Window handles dry keep with mechanism 4 clicks</i>	04	19,90
2654	Martellina dry keep q. 7 c/ros. rettangolare mm 30x65 <i>Window handles dry keep q7x40 with rectangular rose</i>	04	20,50

Prezzi in € - Price in €

ART.	FUTURA DESCRIZIONE	CONF. PEZZI	Z/CS	LNO laccato nero opaco
2601	Coppia di maniglia c/rosetta rettangolare mm 38x50x8 a pressione e bocchetta foro chiave <i>Handle on rose mm 38x50x8 with escutcheon</i>	02	38,40	42,60
2602	Coppia di maniglia c/rosetta quadrata mm 50x50 a pressione e bocchetta foro chiave <i>Handle on rose, square mm 50x50 with escutcheon</i>	02	38,40	
2603	Martellina dry keep q. 7 a 4 scatti c/ros. rettangolare <i>Window handles dry keep with mechanism 4 clicks</i>	04	22,40	23,80



OMEGA
art. 2631

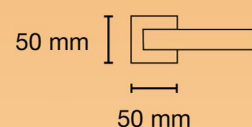
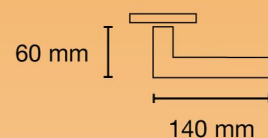

KRONOS
art. 2641

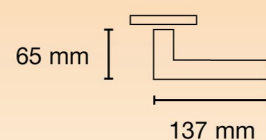

Prezzi in € - Price in €

ART.	OMEGA DESCRIZIONE	CONF. PEZZI	Z/CS
2631	Maniglia c/rosetta quadrata mm 50x50 e bocchetta a pressione <i>Handle on rose, square mm 50x50 with escutcheon</i>	02	40,90
2633	Martellina dry keep c/ros. rettangolare mm 30x65 <i>Window handles dry keep with mechanism 4 clicks</i>	04	23,50

Prezzi in € - Price in €

ART.	KRONOS DESCRIZIONE	CONF. PEZZI	Z/CS
2641	Maniglia c/rosetta tonda Ø50 mm e bocchetta a pressione <i>Handle on rose round mm 50 with escutcheon</i>	02	29,40
2643	Martellina dry keep q. 7 c/ros. ovale movimento a 4 scatti <i>Window handles dry keep with mechanism 4 clicks</i>	04	19,30

QUASAR

art. 2381

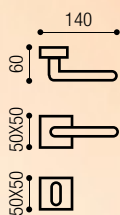
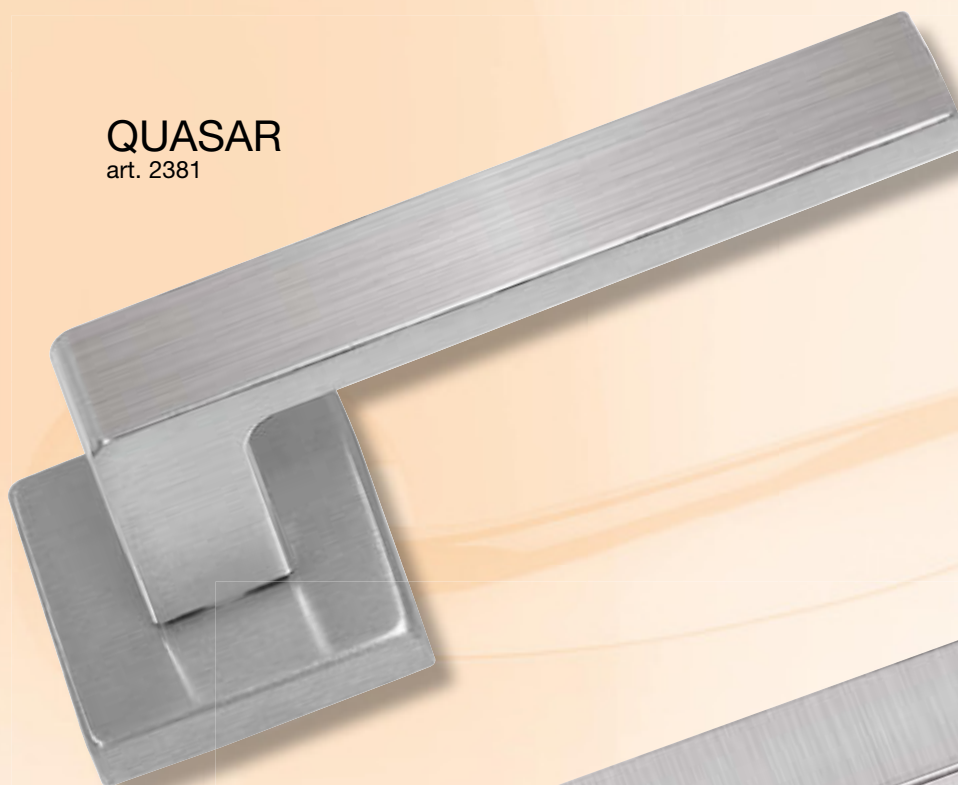

QUASAR-R

art. 2385

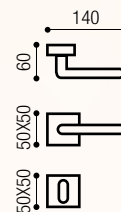
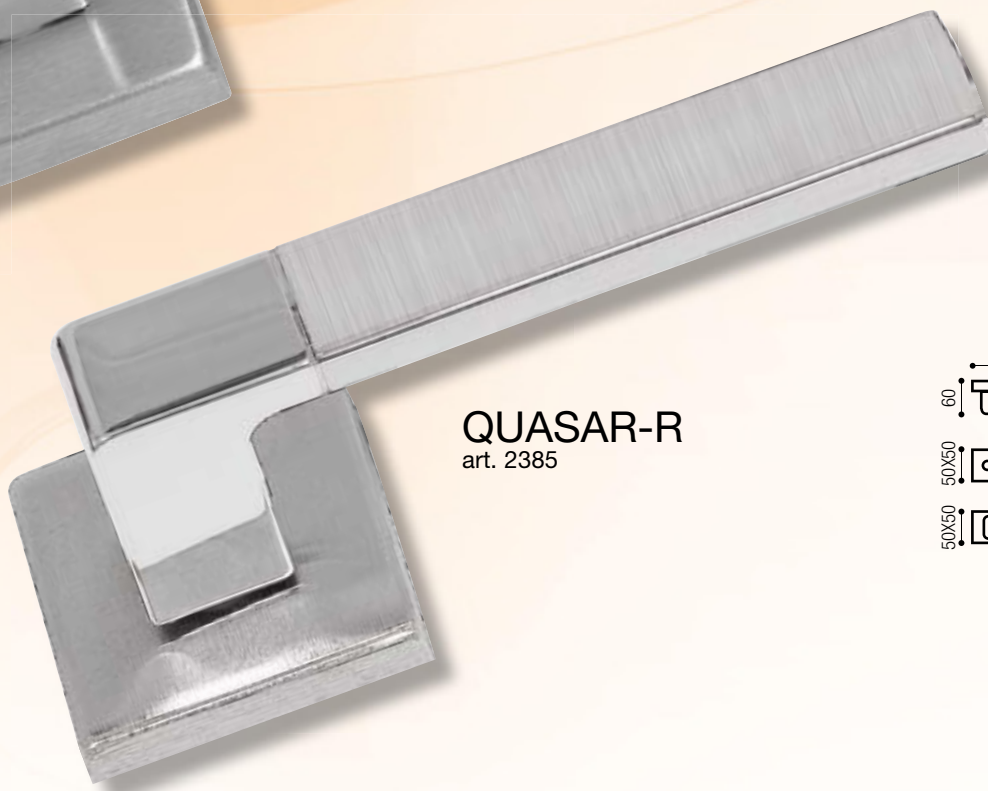

Prezzi in € - Price in €

ART.	DESCRIZIONE	CONF. PEZZI	Z/GS	Z/CR	Z/CR.CS
QUASAR					
2381	Coppia maniglia c/rosetta quadrata 50x50 a pressione e bocchetta foro chiave <i>Handles on rose, square mm 50x50 with escutcheon</i>	01	40,00	43,50	
2382	Coppia maniglia c/rosetta quadrata 50x50 ad avvitare e bocchetta foro chiave <i>Handles on rose, square mm 50x50 to screw with escutcheon</i>	01	49,00		
2383	Martellina q.7 dry keep a 4 scatti c/rosetta rettangolare <i>Window handle dry keep with mechanism 4 clicks</i>	02	18,60	20,60	
QUASAR-R					
2385	Coppia maniglia c/rosetta quadrata 50x50 a pressione e bocchetta foro foro chiave <i>Handles on rose, square mm 50x50 with escutcheon</i>	01			44,50
2386	Coppia maniglia c/rosetta quadrata (bicolore) 50x50 ad avvitare e bocchetta foro foro chiave <i>Handles on rose, square mm 50x50 to screw with escutcheon</i>	01			50,00
2387	Martellina q.7 dry keep a 4 scatti c/rosetta rettangolare <i>Window handle dry keep with mechanism 4 clicks</i>	02			20,00

ATHENA
art. 2541

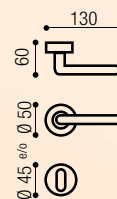
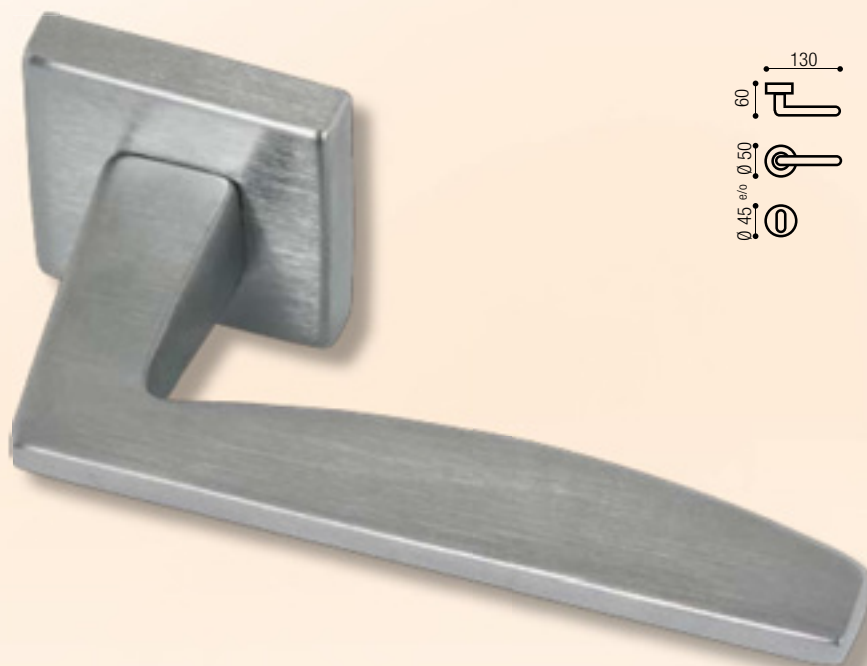

ATLANTA
art. 2545

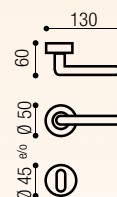

Prezzi in € - Price in €

ART.	DESCRIZIONE	CONF. PEZZI	Z/CS	Z/CS.CR
ATHENA				
2541	Coppia maniglia c/rosetta quadrata mm 50x50 a pressione e bocchetta oro foro chiave <i>Handles on rose, square mm 50x50 with escutcheon</i>	01	41,50	
2542	Coppia maniglia c/rosetta quadrata mm 50x50 ad avvitare e bocchetta oro foro chiave <i>Handles on rose, square mm 50x50 to screw with escutcheon</i>	01	52,00	52,00
2543	Martellina q.7 dry keep a 4 scatti c/rosetta rettangolare <i>Window handle dry keep with mechanism 4 clicks</i>	02	20,50	
ATLANTA				
2545	Coppia maniglia c/rosetta quadrata mm 50x50 a pressione e bocchetta foro chiave <i>Handles on rose, square mm 50x50 with escutcheon</i>	01	41,50	
2546	Coppia maniglia c/rosetta quadrata mm 50x50 ad avvitare e bocchetta foro chiave <i>Handles on rose, square mm 50x50 to screw with escutcheon</i>	01	52,00	52,00
2547	Martellina dry keep q.7 c/rosetta rettangolare movimento a 4 scatti <i>Window handles dry keep with mechanism 4 clicks</i>	02	20,50	

Z/CS.CR: maniglia con rosetta bicolore base ocr/anello ocs

GALATEA

art. 2561



art. 2562



GALATEA-R

art. 2571



art. 2572

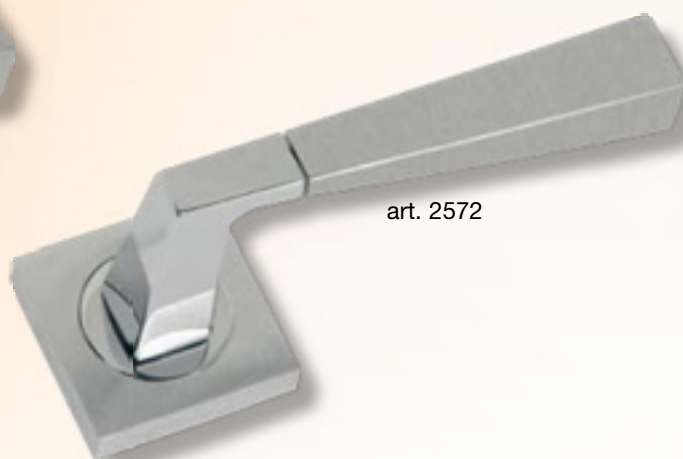

Prezzi in € - Price in €

ART.	DESCRIZIONE	CONF. PEZZI	OCS	OCS.CR
GALATEA				
2561	Coppia maniglia c/rosetta quadra mm 50x50 a pressione e bocchetta foro chiave <i>Handles on rose, Ø45 with escutcheon</i>	01	44,50	
2562	Coppia maniglia c/rosetta quadra Ø50 ad avvitare e bocchetta foro chiave <i>Handles on rose, square mm 50x50 to screw with escutcheon</i>	01	56,00	56,00
2563	Martellina q.7 dry keep a 4 scatti c/rosetta rettangolare <i>Window handle dry keep with mechanism 4 clics</i>	02	24,00	
GALATEA-R				
2571	Coppia maniglia c/rosetta quadrata mm 50x50 a pressione e bocchetta foro chiave <i>Handles on rose, square mm 50x50 with escutcheon</i>	01		46,50
2572	Coppia maniglia c/rosetta quadrata mm 50x50 ad avvitare e bocchetta foro chiave <i>Handles on rose, square mm 50x50 to screw with escutcheon</i>	01		58,50
2573	Martellina dry keep q.7 c/rosetta rettangolare movimento a 4 scatti <i>Window handles dry keep with mechanism 4 clics</i>	02		26,00

MIZAR

art. 2392

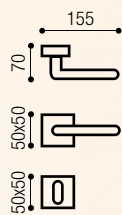
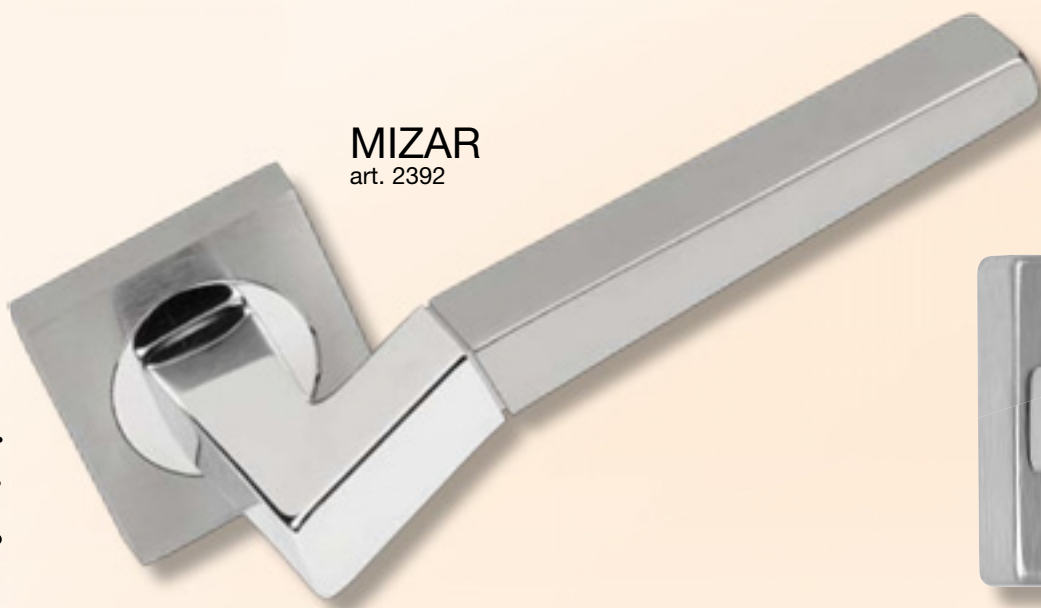

art. 2398

ASTRID

art. 2397

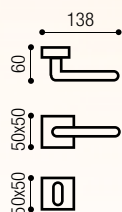

Prezzi in € - Price in €

ART.	DESCRIZIONE	CONF. PEZZI	OCR/OCS	Z/CR.CS	Z/CS
MIZAR					
2392	Coppia maniglia c/rosetta quadrata ad avvitare 50x50 bocchetta foro chiave <i>Handles on rose, square mm 50x50 with escutcheon</i>	01	96,50		
2393	Martellina dry keep q.7 c/rosetta rettangol. movimento a 4 scatti <i>Window handles dry keep with mechanism 4 clicks</i>	02	40,50		
ASTRID					
2396	Coppia maniglia c/rosetta a pressione 50x50 bocchetta foro chiave <i>Handles on rose mm 50x50 square at pressure, with escutcheon</i>	01			48,00
2397	Coppia maniglia c/rosetta quadrata ad avvitare 50x50 bocchetta foro chiave <i>Handles on rose, square mm 50x50 with escutcheon</i>	02		58,00	
2398	Martellina dry keep q.7 c/rosetta rettangol. movimento a 4 scatti <i>Window handles dry keep with mechanism 4 clicks</i>	02			27,00

Z/CR.CS: impugnatura maniglia in cromo sat., assemblata con rosetta bicolore interno cromo luc. e anello cromo sat.

art. 2551

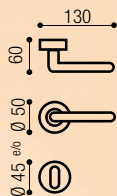

art. 2555

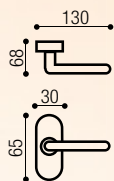

art. 2556

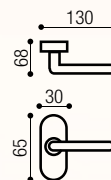

Prezzi in € - Price in €

ART.	DESCRIZIONE	CONF. PEZZI	Z/CS	Z/CS.CR
2551	Coppia maniglia c/rosetta tonda Ø45 a pressione e bocchetta foro chiave <i>Handles on rose, Ø45 with escutcheon</i>	01	24,00	
2552	Coppia maniglia c/rosetta tonda Ø50 ad avvitare e bocchetta foro chiave <i>Handles on rose, square mm 50x50 to screw with escutcheon</i>	01	41,00	41,00
2553	Martellina q.7 dry keep a 4 scatti c/ros. tonda <i>Window handle dry keep with mechanism 4 clics</i>	02	15,00	
2555	Coppia maniglia c/rosetta quadrata 45x45 a pressione e bocchetta foro chiave <i>Handles on rose, square mm 45x45 with escutcheon</i>	01	29,80	
2556	Coppia maniglia c/rosetta quadrata 50x50 ad avvitare e bocchetta foro chiave <i>Handles on rose, square mm 50x50 to screw with escutcheon</i>	01	44,50	44,50
2557	Martellina dry keep q.7 c/rosetta rettangolare movimento a 4 scatti <i>Window handles dry keep with mechanism 4 clics</i>	02	17,00	

Z/CS.CR: maniglia con rosetta bicolore base cr/anello cs

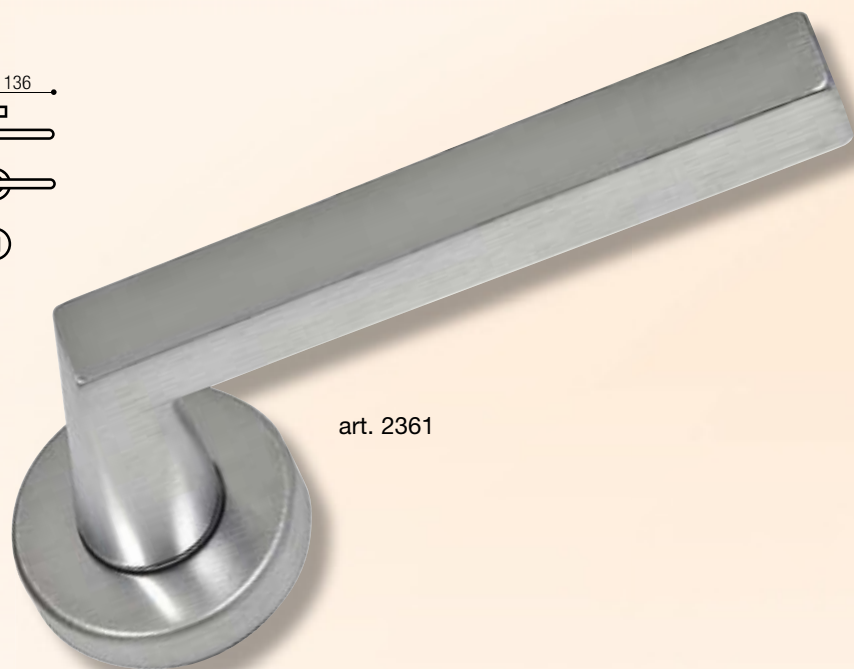
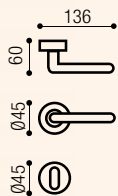

art. 2361

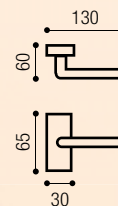

art. 2367Q

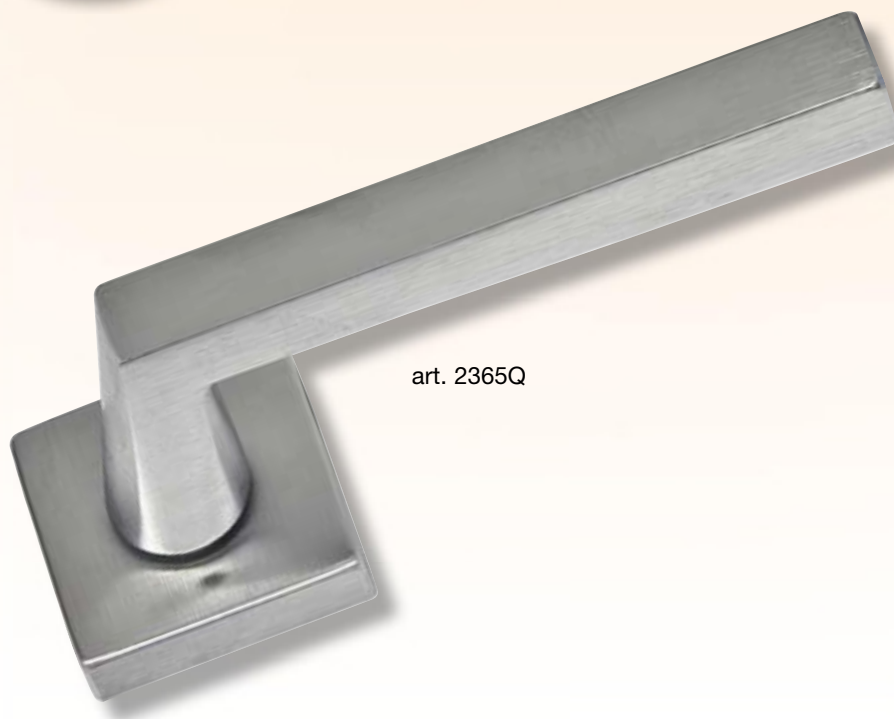
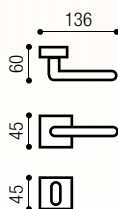

art. 2365Q

Prezzi in € - Price in €

ART.	DESCRIZIONE	CONF. PEZZI	Z/CS
2361	Coppia maniglia con rosetta Ø45 a pressione e bocchetta foro chiave <i>Handles on rose Ø45 screw cover at pressure and escutcheon</i>	02	24,80
2363	Martellina q.7 c/ros. ovale movimento dry keep a 4 scatti <i>Window handle dry keep with mechanism 4 clics</i>	04	17,00
2365Q	Coppia maniglia c/rosetta quadrata 45x45 a pressione e bocchetta foro chiave <i>Handles on rose, square mm 45x45 with escutcheon</i>	02	30,50
2367Q	Martellina dry keep q.7 c/rosetta rettangol. movimento a 4 scatti <i>Window handles dry keep with mechanism 4 clics</i>	04	18,00

art. 2375Q

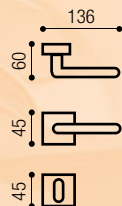
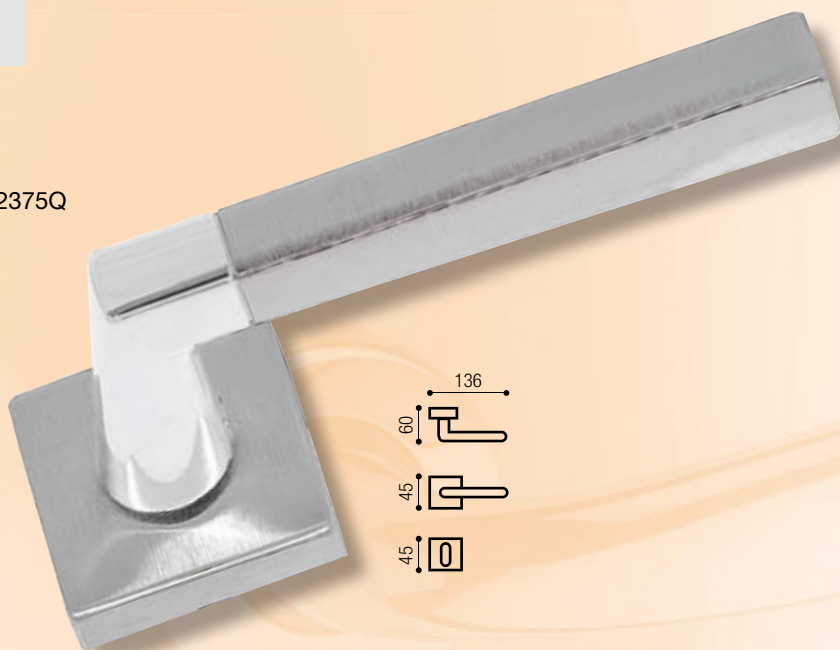

art. 2373

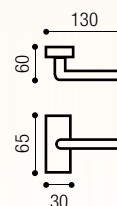

art. 2376Q

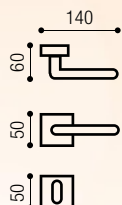
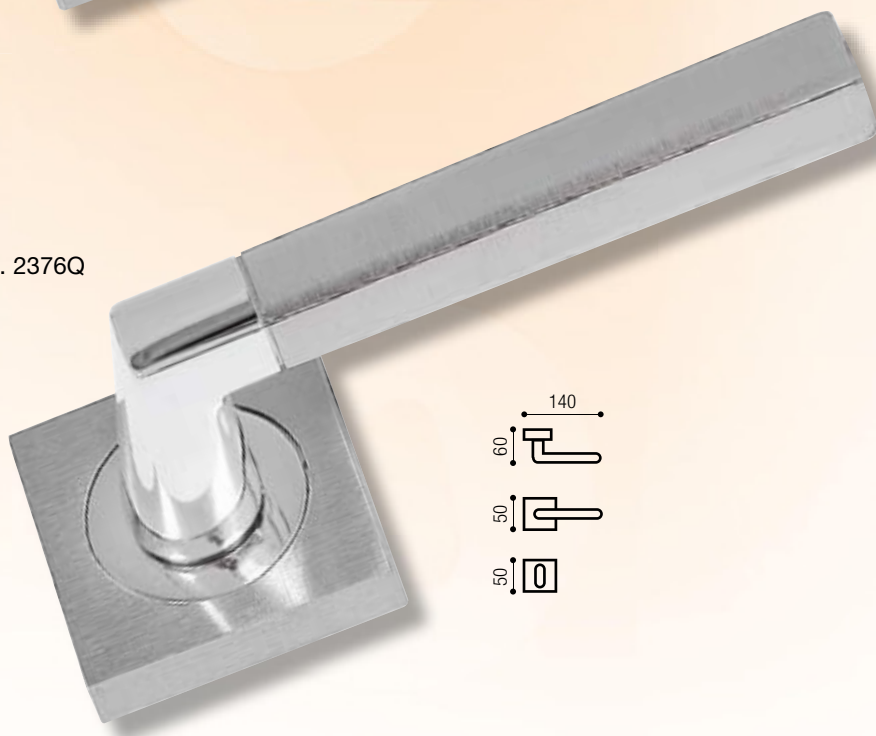

Prezzi in € - Price in €

ART.	DESCRIZIONE	CONF.	Z/CR.CS PEZZI
2371	Coppia maniglia con rosetta Ø45 a pressione e bocchetta foro chiave <i>Handles on rose Ø45 screw cover at pressure and escutcheon</i>	02	28,00
2373	Martellina q.7 c/ros. ovale movimento dry keep a 4 scatti <i>Window handle dry keep with mechanism 4 clics</i>	04	18,80
2375Q	Coppia maniglia c/rosetta quadrata 45x45 a pressione e bocchetta foro chiave <i>Handles on rose, square mm 45x45 with escutcheon</i>	02	34,00
2376Q	Coppia maniglia c/rosetta quadrata ad avvitare 50x50 bocchetta foro chiave <i>Handles on rose, square mm 50x50 with escutcheon</i>	01	45,50
2377Q	Martellina dry keep q.7 c/rosetta rettangol. movimento a 4 scatti <i>Window handles dry keep with mechanism 4 clics</i>	04	19,50

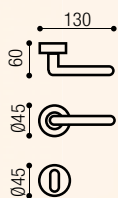

ELEGANT
art. 2581

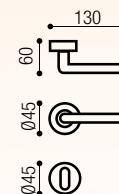

ELEGANT-R
art. 2591



Prezzi in € - Price in €

ART.	DESCRIZIONE	CONF. PEZZI	Z/CS	Z/CR.CS
ELEGANT				
2581	Maniglia c/rosetta Ø45 a pressione e bocchetta foro chiave <i>Handles on rose Ø45 with escutcheon</i>	02	23,00	
2583	Martellina dry keep q.7 <i>Window handle with DK movement</i>	04	15,00	
ELEGANT-R				
2591	Maniglia c/rosetta Ø45 a pressione e bocchetta foro chiave <i>Handles on rose Ø45 with escutcheon</i>	02		26,00
2593	Martellina dry keep q.7 <i>Window handle with DK movement</i>	04		17,00

YVONNE
art. 2102

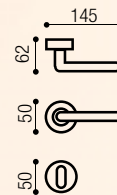

KRISTINA
art. 2112

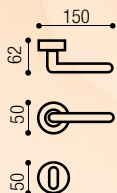

GINEVRA
art. 2122

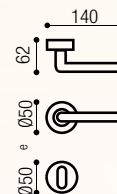

Prezzi in € - Price in €

ART.	DESCRIZIONE	CONF. PEZZI	OCR/OCS	OLV/OSV
YVONNE				
2102	Coppia maniglia con rosetta Ø50 ad avvitare e bocchetta foro chiave <i>Handles on rose Ø50 to screw with escutcheon</i>	01	68,00	
2103	Martellina q.7 movimento dry keep a 4 scatti <i>Window handles dry keep with mechanism 4 clicks</i>	02	38,00	
KRISTINA				
2112	Coppia maniglia con rosetta Ø50 ad avvitare e bocchetta foro chiave <i>Handles on rose Ø50 to screw with escutcheon</i>	01	55,00	55,00
2113	Martellina q.7 movimento dry keep a 4 scatti <i>Window handles dry keep with mechanism 4 clicks</i>	02	26,00	26,00
GINEVRA				
2122	Coppia maniglia con rosetta Ø50 ad avvitare e bocchetta foro chiave <i>Handles on rose Ø50 to screw with escutcheon</i>	01	55,00	55,00
2123	Martellina q.7 movimento dry keep a 4 scatti <i>Window handles dry keep with mechanism 4 clicks</i>	02	26,00	26,00

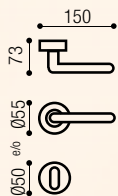
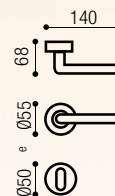
ESEDRA
 art. 2142

ELEKTRA
 art. 2162

Prezzi in € - Price in €

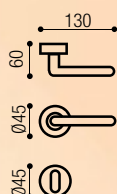
ART.	DESCRIZIONE	CONF.	OCR/OCS PEZZI
ESEDRA			
2142.50	Coppia maniglia con rosetta Ø50 ad avvitare e bocchetta foro chiave <i>Handles on rose Ø50 to screw with escutcheon</i>	01	71,00
2142.55	Coppia maniglia con rosetta bombata Ø55 ad avvitare e bocchetta foro chiave <i>Handles on rose Ø55 to screw with escutcheon</i>	01	77,50
2143	Martellina q.7 movimento dry keep a 4 scatti <i>Window handles dry keep with mechanism 4 clicks</i>	02	32,50
ELEKTRA			
2162.55	Coppia maniglia con rosetta bombata Ø55 ad avvitare e bocchetta foro chiave <i>Handle on rose Ø55 to screw with escutcheon</i>	01	84,00
2163	Martellina q.7 movimento dry keep a 4 scatti <i>Window handles dry keep with mechanism 4 clicks</i>	02	35,50



art. 2411

art. 2416

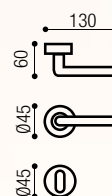

Prezzi in € - Price in €

ART.	DESCRIZIONE	CONF. PEZZI	Z/CS	Z/CR.CS
ZAIRA				
2411	Maniglia c/rosetta Ø45 a pressione e bocchetta foro chiave <i>Handles on rose Ø45 with escutcheon</i>	02	26,00	
2413	Martellina dry keep q.7 <i>Window handle with DK movement</i>	04	15,00	
ZAIRA-R				
2416	Maniglia c/rosetta Ø45 a pressione e bocchetta foro chiave <i>Handles on rose Ø45 with escutcheon</i>	02		29,00
2417	Maniglia c/rosetta Ø50 ad avvitare e bocchetta foro chiave <i>Handles on rose Ø50 to screw with escutcheon</i>	01		43,40
2419	Martellina dry keep q.7 <i>Window handles with DK movement</i>	04		17,00

art. 2312

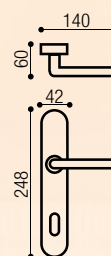
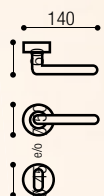

art. 2310

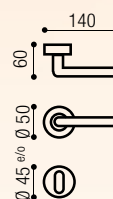

art. 2311

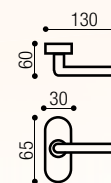

art. 2313



Prezzi in € - Price in €

ART.	DESCRIZIONE	CONF.	OLV/OSV	OCR/OCS
		PEZZI		
2310.1	Coppia maniglia con placca e due molle (pl. 01 mm 248x42) vedi pag. 187 <i>Door handles on plate and two springs, look on page n. 187</i>	01	48,50	48,50
2311	Coppia maniglia c/rosetta Ø45 a pressione e bocchetta foro chiave <i>Handle on rose Ø45 with escutcheon</i>	02	40,00	40,00
2312	Coppia maniglia c/rosetta Ø50 ad avvitare e bocchetta foro chiave <i>Handle on rose Ø50 to screw with escutcheon</i>	01	56,50	56,50
2313	Martellina dry keep q.7 <i>Window handle with DK movement</i>	02	23,50	23,50
2316	Cremonese impugn. maniglia con movimento gratz <i>Window handle with handle impugnation</i>	02	35,50	35,50
2317	Martellina q.7 impugnatura a maniglia <i>Window handles q.7 spindle without movement</i>	02	35,50	35,50

art. 550

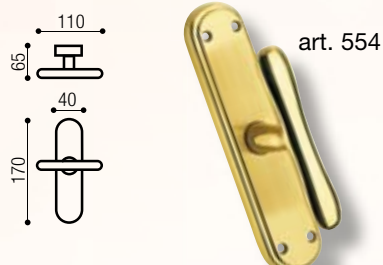
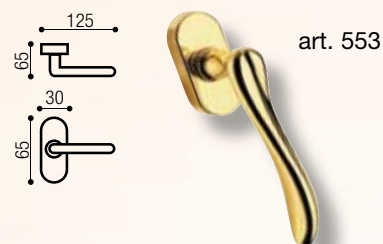
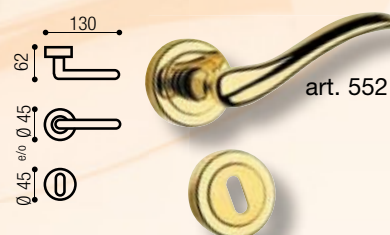
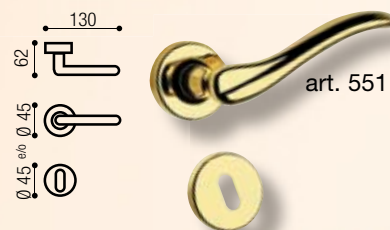
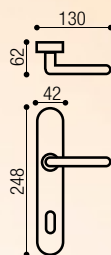

Prezzi in € - Price in €

ART.	DESCRIZIONE	CONF. PEZZI	OLV	OLS	OBG	B/INV	OCS
550	Coppia maniglia con placca e due molle <i>Handle on plate and two springs</i>	01	35,00	35,00	35,00	36,00	37,00
551	Coppia maniglia c/rosetta Ø45 a pressione e bocchetta foro chiave <i>Handle on rose Ø45 with escutcheon</i>	02	26,00	27,00	27,00	28,00	28,00
552	Coppia maniglia c/rosetta Ø50 ad avvitare e bocchetta foro chiave <i>Handle on rose Ø50 to screw with escutcheon</i>	01	39,50	41,50	41,50	42,00	42,00
553	Martellina dry keep q.7 <i>Window handle with DK movement</i>	04	16,00	17,00	17,00	17,50	17,50
554	Cremonese con movimento gratz <i>Window handle with gratz movement</i>	02	20,50	21,00	21,00	22,00	23,00
555	Martellina q.7 <i>Window handle q.7 spindle</i>	02	20,50	21,00	21,00	22,00	23,00
557	Coppia maniglia c/rosetta ovale 32x62 coprivite a pressione e bocchetta foro chiave yale <i>Handle on oval rose with escutcheon</i>	02	27,50		29,00		29,00

art. 540

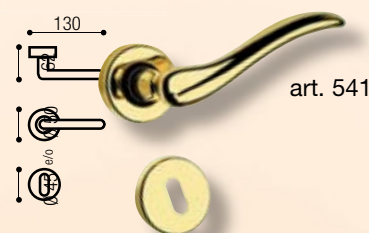
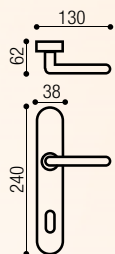

art. 541

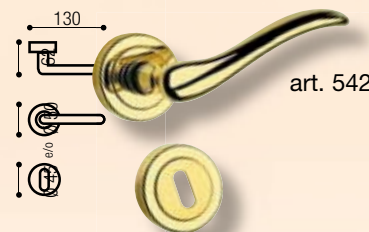

art. 542

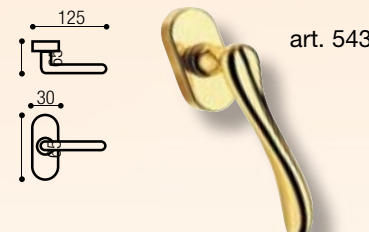

art. 543

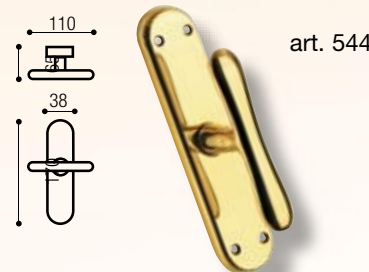

art. 544

Prezzi in € - Price in €

ART.	DESCRIZIONE	CONF. PEZZI	OLV	OBG	B/INV	B/ANT	OCS	OSV
540	Coppia maniglia assemblata su placca (pl. 03 mm 235x38) vedi pag.187 <i>Handle on plate and two springs, see on page 187</i>	01	32,00	33,00	33,50	33,50	34,50	33,50
541	Coppia maniglia c/rosetta Ø45 a pressione e bocchetta foro chiave <i>Handle on rose Ø45 with escutcheon</i>	02	26,00	27,00	28,00	28,00	28,00	28,00
542	Coppia maniglia c/rosetta Ø50 ad avvitare e bocchetta foro chiave <i>Handle on rose Ø50 to screw with escutcheon</i>	01	39,50	41,50	42,00	42,00	42,00	
543	Martellina dry keep q.7 <i>Window handle with DK movement</i>	04	16,00	17,00	17,50	17,50	17,50	17,50
544	Cremonese con movimento gratz <i>Window handle with gratz movement</i>	02	19,50	20,00	21,00	21,00	20,50	20,50
545	Martellina q.7 <i>Window handle q.7 spindle</i>	02	19,50	20,00	21,00	21,00	20,50	20,50
547	Coppia maniglia c/rosetta ovale 32x62 coprivatea pressione e bocchetta foro chiave yale <i>Handle on oval rose with escutcheon cylinder key hole</i>	02	27,50	29,00			29,00	29,00

art. 962

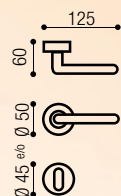

art. 966

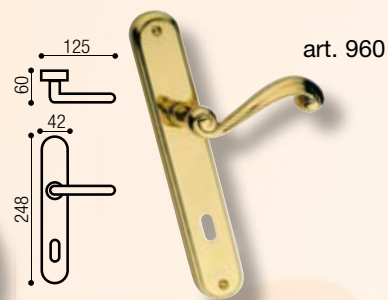

art. 960

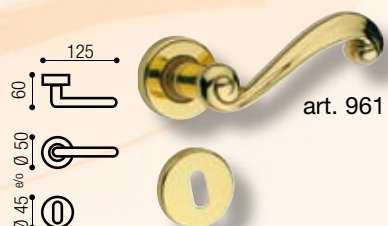
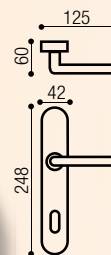

art. 961

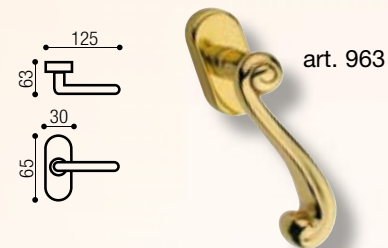
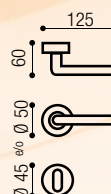

art. 963

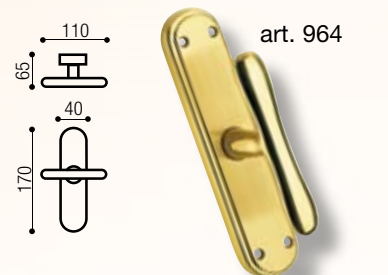
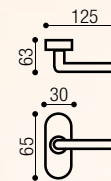

art. 964

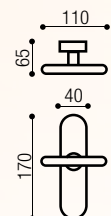

Prezzi in € - Price in €

ART.	DESCRIZIONE	CONF. PEZZI	OLV	OBG	B/INV
960	Coppia maniglia con placca e due molle <i>Handle on plate and two springs</i>	01	37,00	38,50	38,50
961	Coppia maniglia c/rosetta Ø45 a pressione e bocchetta foro chiave <i>Handle on rose Ø45 with escutcheon</i>	02	29,00	30,00	30,00
962	Coppia maniglia c/rosetta Ø50 ad avvitare e bocchetta foro chiave <i>Handle on rose Ø50 to screw with escutcheon</i>	01	41,50	43,50	43,50
963	Martellina dry keep q.7 <i>Window handle with DK movement</i>	02	19,00	20,00	20,00
964	Cremonese con movimento gratz <i>Window handle with gratz movement</i>	02	21,50	21,50	21,50
965	Martellina q.7 <i>Window handle q.7 spindle</i>	02	21,50	21,50	21,50
966	Cremonese impugnatura a maniglia <i>Window handle with handle impugnation</i>	02	24,50	25,50	25,50
967	Coppia maniglia c/rosetta ovale 32x62 coprivite a pressione e bocchetta foro chiave yale <i>Handle on oval rose with escutcheon</i>	02	30,50	31,50	31,50

art. 922

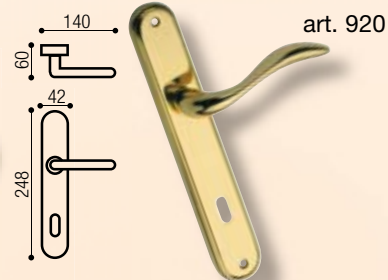
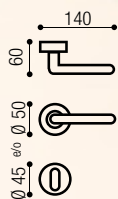

art. 920

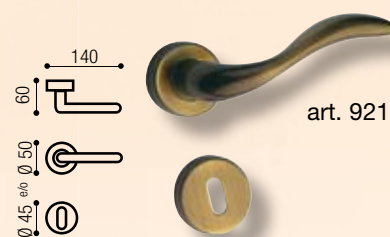

art. 921

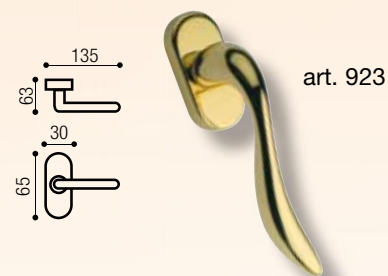

art. 923

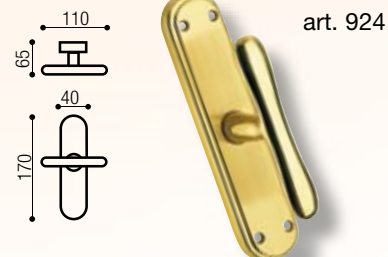

art. 924

Prezzi in € - Price in €

ART.	DESCRIZIONE	CONF. PEZZI	OLV	OBG	OLS	OCS
920	Coppia maniglia con placca e due molle (assemblata su placca 01) vedi pag. 187 <i>Handle on plate and two springs, look on page n. 187</i>	01	38,50	38,50	38,50	41,00
921	Coppia maniglia c/rosetta Ø45 a pressione e bocchetta foro chiave <i>Handle on rose Ø45 with escutcheon</i>	02	30,50	31,50	31,50	32,50
922	Coppia maniglia c/rosetta Ø50 ad avvitare e bocchetta foro chiave <i>Handle on rose Ø50 to screw with escutcheon</i>	01	42,90	44,90	44,90	46,90
923	Martellina dry keep q.7 <i>Window handle with DK movement</i>	02	18,00	18,50	18,50	19,00
924	Cremonese con movimento gratz <i>Window handle with gratz movement</i>	02	21,50	21,50	21,50	23,50
925	Martellina q.7 <i>Window handle q.7 spindle</i>	02	21,50	21,50	21,50	23,50
927	Coppia maniglia c/rosetta ovale 32x62 coprivite a pressione e bocchetta foro chiave yale <i>Handle on oval rose with escutcheon</i>	02	36,00	38,00	38,00	40,50



art. 2262

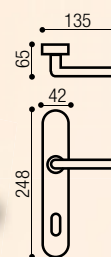
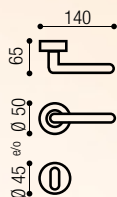

art. 2260

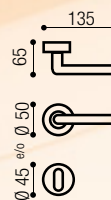

art. 2261

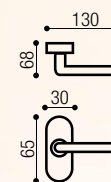

art. 2263

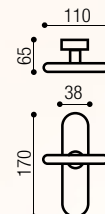

art. 2264

Prezzi in € - Price in €

ART.	DESCRIZIONE	CONF. PEZZI	OLV	OCS
2260	Coppia maniglia con placca e due molle (assemblate con placca 01) vedi pag. 187 <i>Handles on plate and two springs, look on page 187</i>	01	44,50	44,50
2261	Coppia maniglia c/rosetta Ø45 a pressione e bocchetta foro chiave <i>Handles on rose Ø45 with escutcheon</i>	02	36,50	36,50
2262	Coppia maniglia c/rosetta Ø50 ad avvitare e bocchetta foro chiave <i>Handles on rose Ø50 to screw with escutcheon</i>	01	49,50	49,50
2263	Martellina dry keep q.7 <i>Window handles with DK movement</i>	04	22,00	22,00
2264	Cremonese con movimento gratz <i>Window handles with gratz movement</i>	02	20,50	23,00
2265	Martellina q.7 <i>Window handles q.7 spindle</i>	02	20,50	23,00
2268	Coppia maniglia c/rosetta ovale 32x62 coprivite a pressione e bocchetta foro chiave yale <i>Handles on oval rose with escutcheon</i>	02	38,00	38,00

art. 750

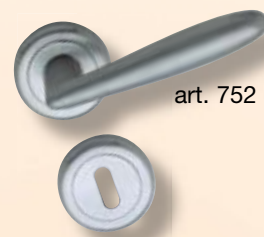
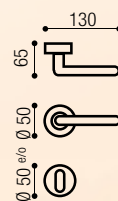
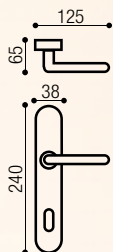

art. 752

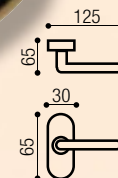

art. 753

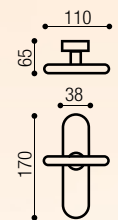

art. 754

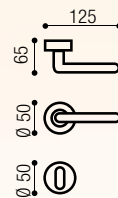

art. 757

Prezzi in € - Price in €

ART.	DESCRIZIONE	CONF. PEZZI	OLV	OBG	OCR	OCS	OSV
750	Coppia maniglia assemblata su placca (pl. 03 mm 38x240) vedi pag. 187 <i>Handle on plate and two springs 38x240 mm, look on page 187</i>	01	31,60	32,60	34,60	33,50	
751	Coppia maniglia c/rosetta Ø45 a pressione e bocchetta foro chiave <i>Handle on rose Ø45 with escutcheon</i>	02	26,00	27,50	29,00	27,50	27,50
752	Kit Maniglia c/rosetta Ø50 ad avvitare e bocchetta foro chiave <i>Handle on rose Ø50 to screw with escutcheon</i>	01	39,50	41,50	43,00	42,50	41,50
753	Martellina dry keep q.7 <i>Window handle with DK movement</i>	04	16,00	17,00	18,00	17,00	17,00
754	Cremonese con movimento gratz <i>Window handle with gratz movement</i>	02	19,50	20,00	22,00	20,50	20,50
755	Martellina q.7 <i>Window handle q.7 spindle</i>	02	19,50	20,00	22,00	20,50	20,50
757	Coppia maniglia c/rosetta ovale 32x62 coprivite a pressione e bocchetta foro chiave yale <i>Handle on oval rose with escutcheon</i>	01	27,00	28,50	30,00	28,50	28,50



art. 160

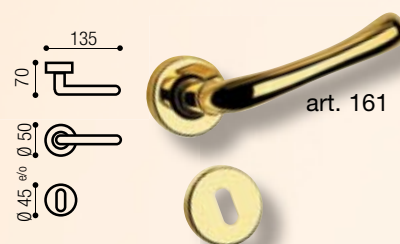
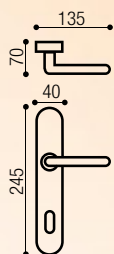

art. 161

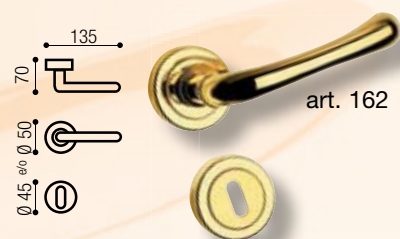

art. 162

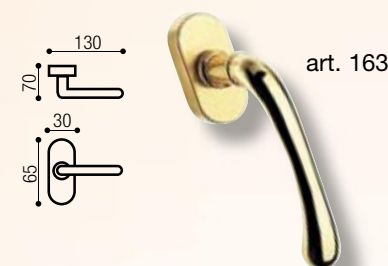

art. 163

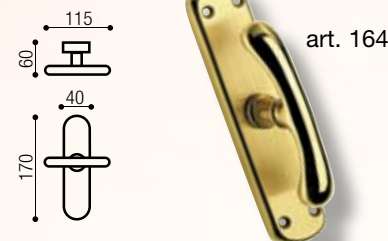

art. 164

Prezzi in € - Price in €

ART.	DESCRIZIONE	CONF. PEZZI	OLV	OLS	OBG	OCS
160	Coppia maniglia con placca e due molle <i>Handle on plate and two springs</i>	01	35,50	35,50	36,50	38,00
161	Coppia maniglia c/rosetta Ø45 a pressione e bocchetta foro chiave <i>Handle on rose Ø45 with escutcheon</i>	02	25,50	27,00	27,00	28,00
162	Coppia maniglia c/rosetta Ø50 ad avvitare e bocchetta foro chiave <i>Handle on rose Ø50 to screw with escutcheon</i>	01	38,50		41,00	42,00
163	Martellina dry keep q.7 <i>Window handle with DK movement</i>	04	16,00	17,00	17,00	17,50
164	Cremonese con movimento gratz <i>Window handle with gratz movement</i>	02	20,50	21,00	21,00	23,00
165	Martellina q.7 <i>Window handle q.7 spindle</i>	02	20,50	21,00	21,00	23,00
166	Cremonese impugnatura a maniglia <i>Window handles with handle impugnation</i>	02	22,10	22,60	22,60	24,60
168	Coppia maniglia c/rosetta ovale 32x62 coprivite a pressione e bocchetta foro chiave yale <i>Handles on oval rose with escutcheon</i>	02	26,50		28,00	29,00



art. 560

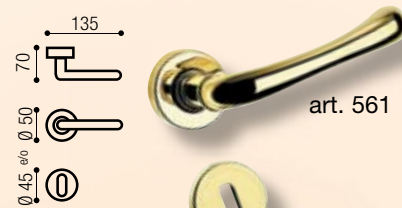
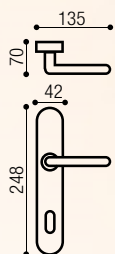

art. 561

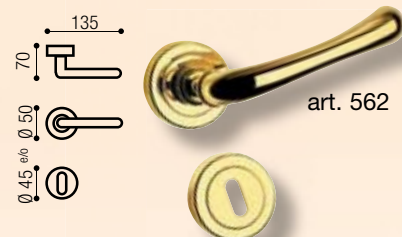

art. 562

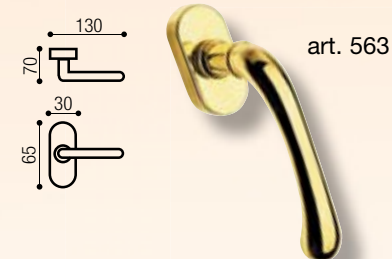

art. 563

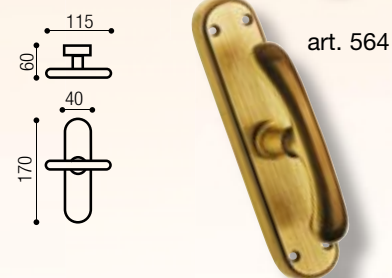

art. 564

Prezzi in € - Price in €

ART.	DESCRIZIONE	CONF. PEZZI	OLV	OLS	OBG	OCS
560	Coppia maniglia con placca e due molle <i>Handle on plate and two springs</i>	01	37,00	37,00	37,00	39,00
561	Coppia maniglia c/rosetta Ø45 a pressione e bocchetta foro chiave <i>Handle on rose Ø45 with escutcheon</i>	02	25,50	27,00	27,00	28,00
562	Coppia maniglia c/rosetta Ø50 ad avvitare e bocchetta foro chiave <i>Handle on rose Ø50 to screw with escutcheon</i>	01	38,50		41,00	42,00
563	Martellina dry keep q.7 <i>Window handle with DK movement</i>	04	16,00	17,00	17,00	17,50
564	Cremonese con movimento gratz <i>Window handle with gratz movement</i>	02	21,50	22,00	22,00	24,00
565	Martellina q.7 <i>Window handle q.7 spindle</i>	02	21,50	22,00	22,00	24,00
567	Coppia maniglia c/rosetta ovale 32x62 coprivite a pressione e bocchetta foro chiave yale <i>Handle on oval rose with escutcheon</i>	02	26,50		28,00	29,00

art. 202

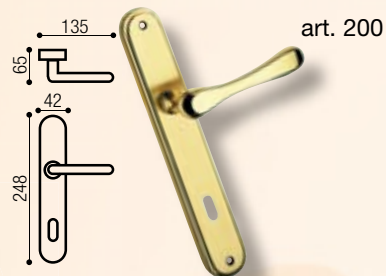
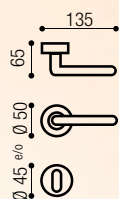

art. 200

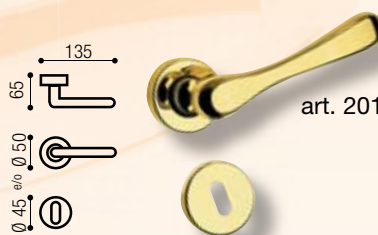
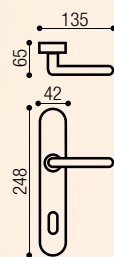

art. 201

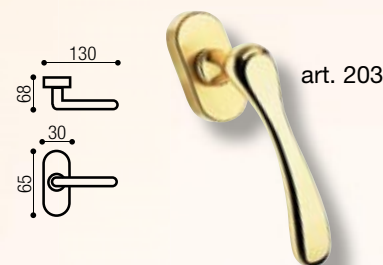
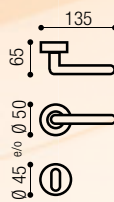

art. 203

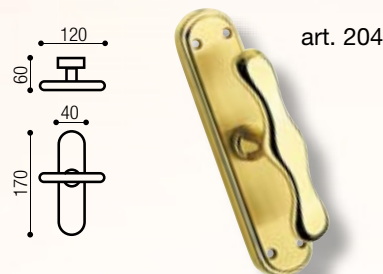
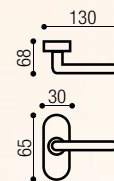

art. 204

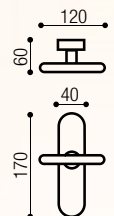

Prezzi in € - Price in €

ART.	DESCRIZIONE	CONF. PEZZI	OLV	OLS	OBG	OCS
200	Coppia maniglia con placca e due molle (assemblata su placca 01) vedi pag. 187 <i>Handle on plate and two springs, look on page 187</i>	01	37,00	37,00	37,00	39,00
201	Coppia maniglia c/rosetta Ø45 a pressione e bocchetta foro chiave <i>Handle on rose Ø45 with escutcheon</i>	02	28,00	29,00	29,00	30,00
202	Coppia maniglia c/rosetta Ø50 ad avvitare e bocchetta foro chiave <i>Handle on rose Ø50 to screw with escutcheon</i>	01	40,00	43,50	43,50	45,00
203	Martellina dry keep q.7 <i>Window handle with DK movement</i>	04	17,50	18,50	18,50	19,50
204	Cremonese con movimento gratz <i>Window handle with gratz movement</i>	02	22,00	22,50	22,50	23,50
205	Martellina q.7 <i>Window handle q.7 spindle</i>	02	22,00	22,50	22,50	23,50
207	Coppia maniglia c/rosetta ovale 32x62 Coprivite a pressione e bocchetta foro chiave yale <i>Handle on oval rose with escutcheon</i>	02	29,50		30,50	31,50

art. 2172

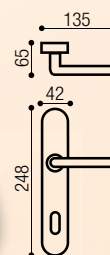
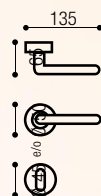

art. 2170

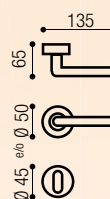

art. 2171

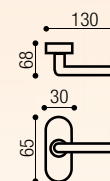

art. 2173

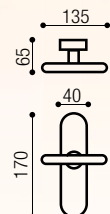

art. 2174



Prezzi in € - Price in €

ART.	DESCRIZIONE	CONF.	OLV/OSV	OCR/OCS	PEZZI
2170	Coppia maniglia con placca e due molle (placca 01 mm 248x42) vedi pag. 187 <i>Door handle on plate and two springs, look on page 187</i>	01	49,50	49,50	
2171	Coppia maniglia c/rosetta Ø45 a pressione e bocchetta foro chiave <i>Handle on rose Ø45 with escutcheon</i>	01	41,00	41,00	
2172	Coppia maniglia c/rosetta Ø50 ad avvitare e bocchetta foro chiave <i>Handle on rose Ø50 to screw with escutcheon</i>	01	56,00	56,00	
2173	Martellina dry keep q.7 <i>Window handle with DK movement</i>	04	23,50	23,50	
2174	Cremonese impugnatura maniglia con movimento gratz <i>Window handle with handle impugnation</i>	02	27,50	27,50	
2175	Martellina q.7 impugnatura a maniglia <i>Window handle q.7 spindle without movement</i>	02	27,50	27,50	

art. 730

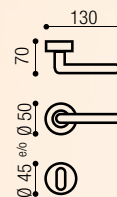
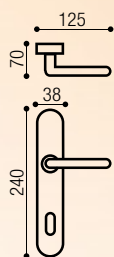

art. 731

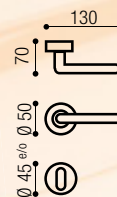

art. 732

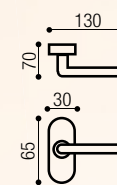

art. 733

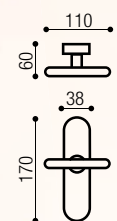

art. 734

Prezzi in € - Price in €

ART.	DESCRIZIONE	CONF. PEZZI	OLV	OBG	OCR	OCS
730	Coppia maniglia con placca e due molle (pl. 03 mm 38x240) vedi pag. 187 <i>Handle on plate and two springs, look on page 187</i>	01	31,60	32,60	34,60	33,50
731	Coppia maniglia c/rosetta Ø45 a pressione e bocchetta foro chiave <i>Handle on rose Ø45 with escutcheon</i>	02	26,00	27,50	29,00	27,50
732	Coppia maniglia c/rosetta Ø50 ad avvitare e bocchetta foro chiave <i>Handle on rose Ø50 to screw with escutcheon</i>	01	39,50	41,50	43,00	42,50
733	Martellina dry keep q.7 <i>Window handle with DK movement</i>	04	16,00	17,00	18,00	17,00
734	Cremonese con movimento gratz <i>Window handle with gratz movement</i>	02	19,50	20,00	22,00	20,50
735	Martellina q.7 <i>Window handle q.7 spindle</i>	02	19,50	20,00	22,00	20,50
737	Coppia maniglia c/rosetta ovale 32x62 coprivite a pressione e bocchetta foro chiave yale <i>Handle on oval rose with escutcheon</i>	02	27,50	29,00	30,50	29,00

art. 770

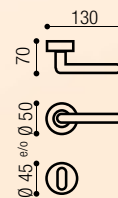
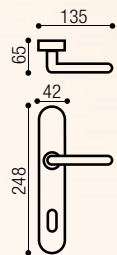

art. 771

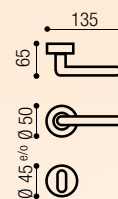

art. 772

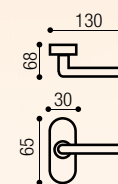

art. 773

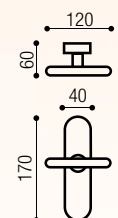

art. 774

Prezzi in € - Price in €

ART.	DESCRIZIONE	CONF. PEZZI	OLV	OLS	OBG	OCS
770	Coppia maniglia con placca e due molle (pl. 01 mm 248x42) vedi pag. 187 <i>Handle on plate and two springs, look on page 187</i>	01	37,00	37,00	37,00	39,00
771	Coppia maniglia c/rosetta Ø45 a pressione e bocchetta foro chiave <i>Handle on rose Ø45 with escutcheon</i>	02	26,00	27,50	27,50	27,50
772	Coppia maniglia c/rosetta Ø50 ad avvitare e bocchetta foro chiave <i>Handle on rose Ø50 to screw with escutcheon</i>	01	39,50		41,50	42,50
773	Martellina dry keep q.7 <i>Window handle with DK movement</i>	04	16,00	17,00	17,00	17,50
774	Cremonese con movimento gratz <i>Window handle with gratz movement</i>	02	21,50	21,50	21,50	23,50
775	Martellina q.7 <i>Window handle q.7 spindle</i>	02	21,50	21,50	21,50	23,50
777	Coppia maniglia c/rosetta ovale 32x62 coprivite a pressione e bocchetta foro chiave yale <i>Handle on oval rose with escutcheon</i>	02	27,50		29,00	29,00

art. 942

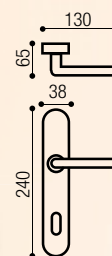
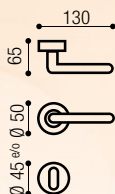

art. 940

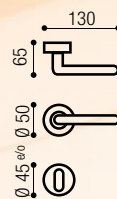

art. 941

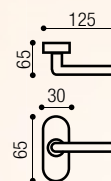
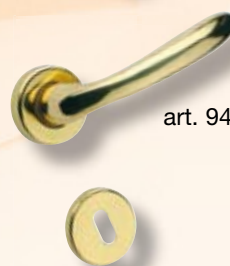

art. 943

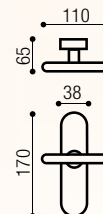

art. 944-945



Prezzi in € - Price in €

ART.	DESCRIZIONE	CONF. PEZZI	OLV	OBG	OCR	OCS	OSV
940	Coppia maniglia con placca e due molle <i>Handle on plate and two springs</i>	01	31,50	32,50	36,00	34,00	32,50
941	Coppia maniglia c/rosetta Ø45 a pressione e bocchetta foro chiave <i>Handle on rose Ø45 with escutcheon</i>	02	25,00	26,50	30,00	28,00	26,50
942	Coppia maniglia c/rosetta Ø50 ad avvitare e bocchetta foro chiave <i>Handle on rose Ø50 to screw with escutcheon</i>	01	38,00	40,50	44,00	42,00	
943	Martellina dry keep q.7 <i>Window handle with DK movement</i>	04	16,00	17,00	19,00	17,50	17,00
944	Cremonese con movimento gratz <i>Window handle with gratz movement</i>	02	19,50	20,00	22,00	20,50	20,50
945	Martellina q.7 <i>Window handle q.7 spindle</i>	02	19,50	20,00	22,00	20,50	20,50
947	Coppia maniglia c/rosetta ovale 32x62 coprivite a pressione e bocchetta foro chiave yale <i>Handle on oval rose with escutcheon cylinder key hole</i>	02	26,50	28,00	31,00	29,50	29,50

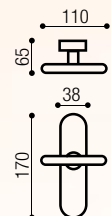
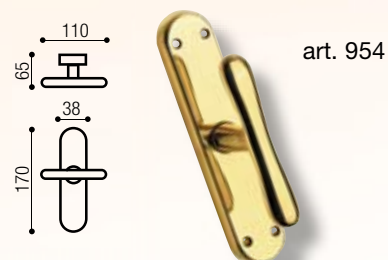
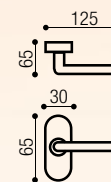
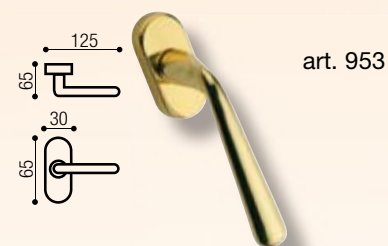
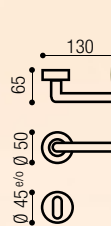
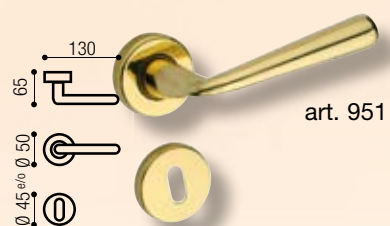
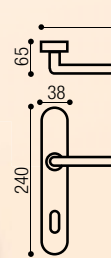
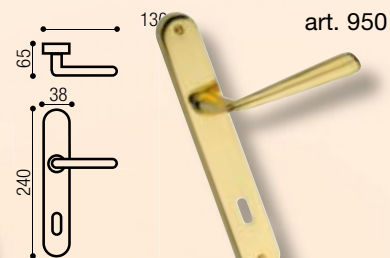
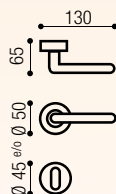

Prezzi in € - Price in €

ART.	DESCRIZIONE	CONF. PEZZI	OLV	OBG	OCR	OCS	OSV
950	Coppia maniglia con placca e due molle <i>Handle on plate and two springs</i>	01	32,00	33,00	36,50	34,50	33,00
951	Coppia maniglia c/rosetta Ø45 a pressione e bocchetta foro chiave <i>Handle on rose Ø45 with escutcheon</i>	02	26,50	27,50	30,50	28,50	27,50
952	Coppia maniglia c/rosetta Ø50 ad avvitare e bocchetta foro chiave <i>Handle on rose Ø50 to screw with escutcheon</i>	01	40,50	42,50	45,00	43,00	
953	Martellina dry keep q.7 <i>Window handle with DK movement</i>	04	17,00	18,00	20,00	18,50	18,00
954	Cremonese con movimento gratz <i>Window handle with gratz movement</i>	02	19,50	20,00	22,00	20,50	20,50
955	Martellina q.7 <i>Window handle q.7 spindle</i>	02	19,50	20,00	22,00	20,50	20,50
957	Coppia maniglia c/rosetta ovale 32x62 coprivite a pressione e bocchetta foro chiave yale <i>Handle on oval rose with escutcheon cylinder key hole</i>	02	28,00	29,00	32,00	30,00	29,00

art. 2152.50

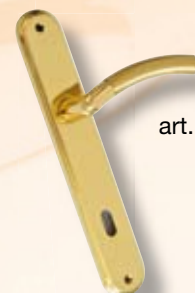
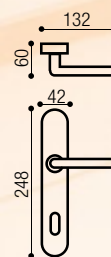
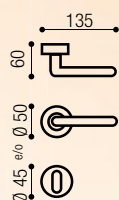

art. 2150

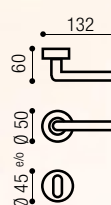

art. 2151

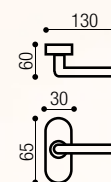

art. 2153

Prezzi in € - Price in €

ART.	DESCRIZIONE	CONF. PEZZI	OLV/OSV	OCR/OCS
2150.1	Coppia maniglia con placca e due molle (assemblate con placca 01) vedi pag. 187 <i>Door handles on plate and and two springs, look on page 187</i>	01	49,50	50,00
2151	Coppia maniglia c/rosetta Ø45 a pressione e bocchetta foro chiave <i>Handles on rose Ø45 with escutcheon</i>	02	39,50	39,50
2152.50	Coppia maniglia c/rosetta Ø50 ad avvitare e bocchetta foro chiave <i>Handles on rose Ø50 to screw with escutcheon</i>	01	56,50	56,50
2152.55	Coppia maniglia c/rosetta bombata Ø55 ad avvitare e bocc. foro chiave <i>Handles on rose Ø55 to screw with escutcheon</i>	01		60,50
2153	Martellina dry keep q.7 <i>Window handle with DK movement</i>	04	23,50	23,50
2154	Cremonese impugn. maniglia con movimento gratz <i>Window handle with handle impugnation</i>	02	27,50	27,50
2155	Martellina q.7 impugnatura a maniglia <i>Window handles q.7 spindle without movement</i>	02	27,50	27,50

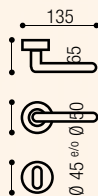

art. 2232.50

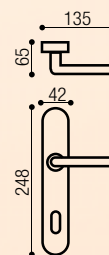
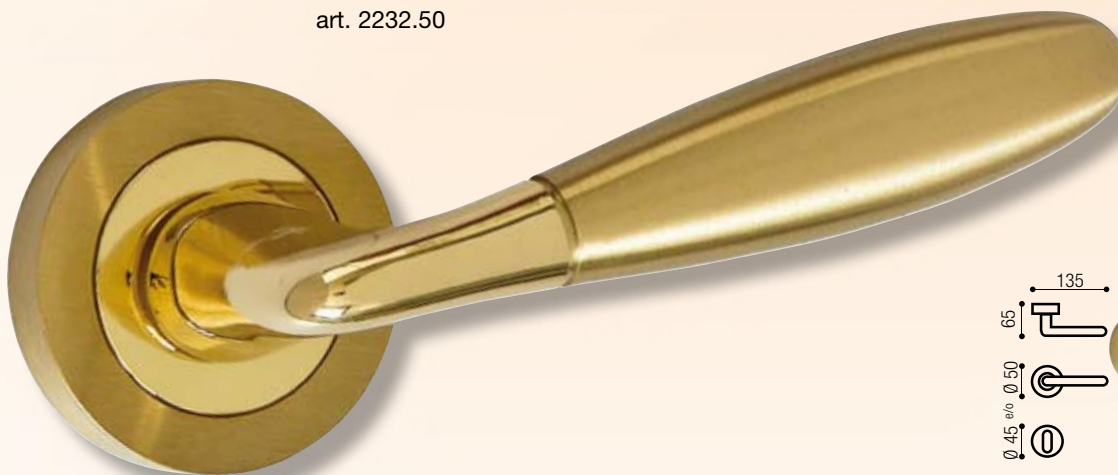

art. 2230

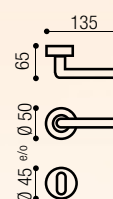

art. 2232

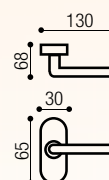

art. 2233



Prezzi in € - Price in €

ART.	DESCRIZIONE	CONF. PEZZI	OLV/OSV	OCR/OCS
2230	Coppia maniglia con placca e due molle (assemblate con placca 01) vedi pag. 187 <i>Door handle on plate and two springs, look on page 187</i>	01	49,50	50,00
2231	Coppia maniglia c/rosetta Ø45 a pressione e bocchetta foro chiave <i>Handle on rose Ø45 with escutcheon</i>	02	39,50	39,50
2232.50	Coppia maniglia c/rosetta Ø50 ad avvitare e bocchetta foro chiave <i>Handle on rose Ø50 to screw with escutcheon</i>	01	56,50	56,50
2232.55	Coppia maniglia c/rosetta bombata Ø55 ad avvitare e bocchetta foro chiave <i>Handle on rose Ø55 to screw with escutcheon</i>	01		60,00
2233	Martellina dry keep q.7 <i>Window handle with DK movement</i>	04	23,50	23,50
2234	Cremonese impugnatura maniglia con movimento gratz <i>Window handle with handle impugnation</i>	02	27,50	27,50
2235	Martellina q.7 impugnatura a maniglia <i>Window handle q.7 spindle without movement</i>	02	27,50	27,50

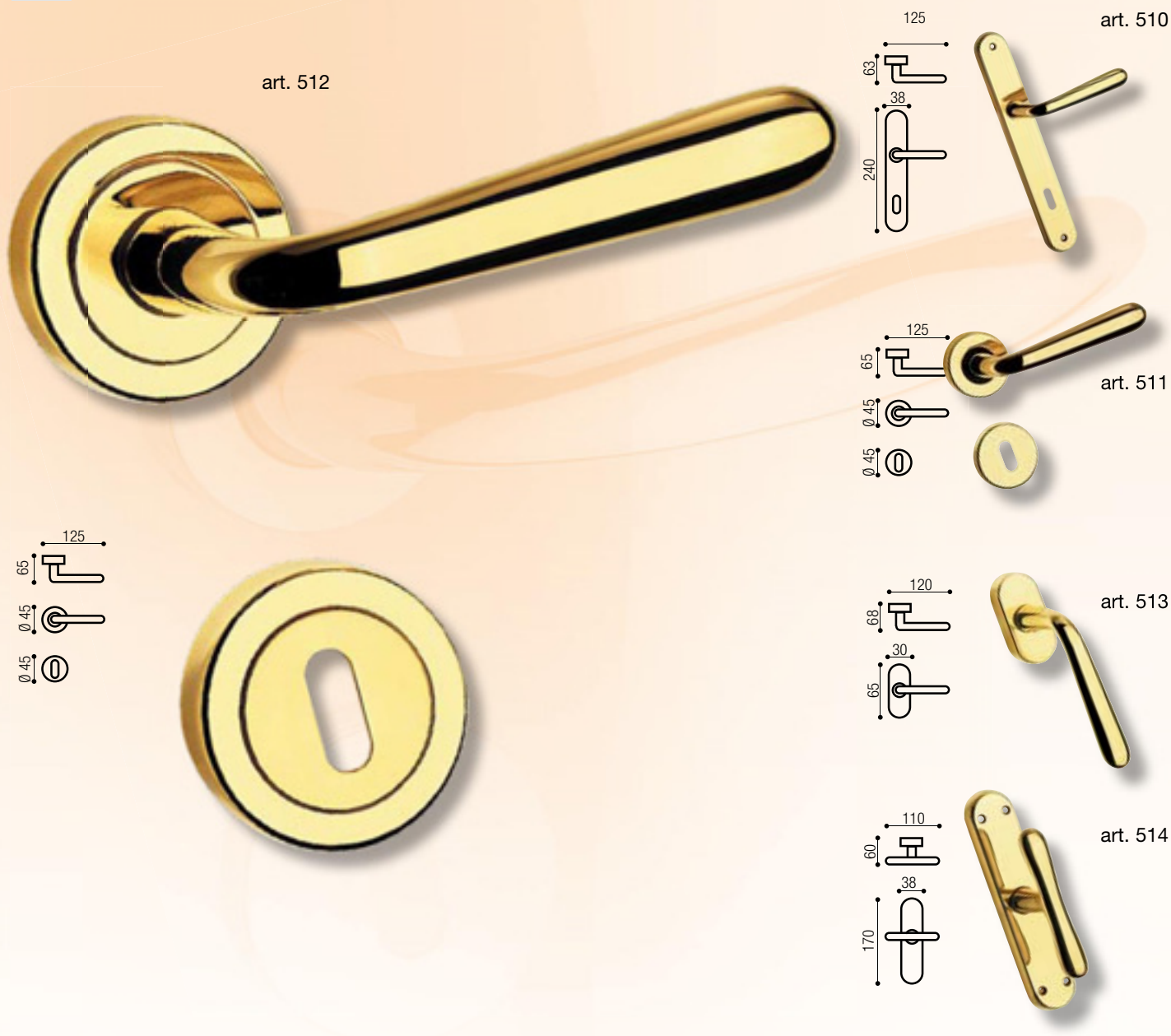

art. 512

art. 510

art. 511

art. 513

art. 514

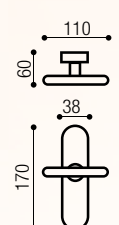
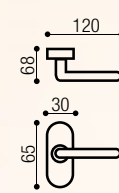
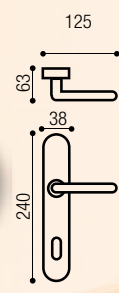
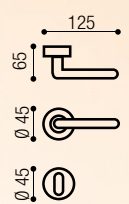

Prezzi in € - Price in €

ART.	DESCRIZIONE	CONF. PEZZI	OLV	OBG	OCR	OCS
510	Maniglia con placca e due molle (pl. 03 mm 38x240) vedi pag. 187 <i>Handle on plate and two springs, look on page 187</i>	01	28,80	29,80	32,00	30,50
511	Maniglia c/rosetta Ø45 a pressione e bocchetta foro chiave <i>Handle on rose Ø45 with escutcheon</i>	02	23,00	24,50	26,00	25,00
512	Kit Maniglia c/rosetta Ø50 ad avvitare e bocchetta foro chiave <i>Handle on rose Ø50 to screw with escutcheon</i>	01	36,00	39,00	40,00	39,00
513	Martellina dry keep q.7 <i>Window handle with DK movement</i>	04	15,00	15,50	17,00	16,00
514	Cremonese con movimento gratz <i>Window handle with gratz movement</i>	02	19,50	20,00	22,00	20,50
515	Martellina q.7 <i>Window handle q.7 spindle</i>	02	19,50	20,00	22,00	20,50
517	Maniglia c/rosetta ovale 32x62 coprivite a pressione e bocchetta foro chiave yale <i>Handle on oval rose with escutcheon</i>	02	26,00	27,50	29,00	28,00

art. 721

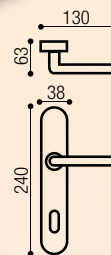
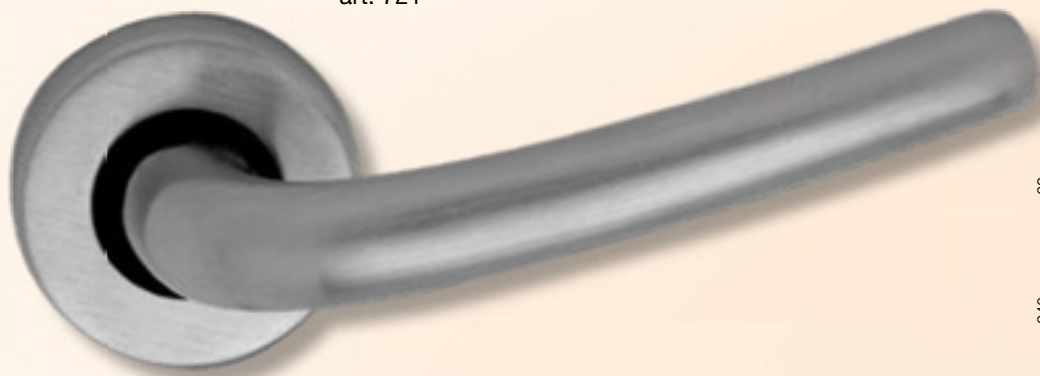

art. 720

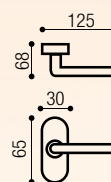

art. 723

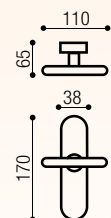

art. 724

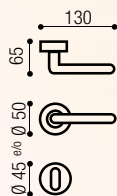

Prezzi in € - Price in €

ART.	DESCRIZIONE	CONF. PEZZI	OLV	OBG	OCR	OCS
720	Maniglia con placca e due molle (pl. 03 mm 38x240) vedi pag. 187 <i>Handle on plate and two springs, look on page 187</i>	01	26,80	27,80	30,00	28,50
721	Maniglia c/rosetta Ø45 a pressione e bocchetta foro chiave <i>Handle on rose Ø45 with escutcheon</i>	02	21,00	22,50	24,00	21,50
722	Maniglia c/rosetta Ø50 ad avvitare e bocchetta foro chiave <i>Handle on rose Ø50 to screw with escutcheon</i>	01	33,50	36,50	37,50	36,50
723	Martellina dry keep q.7 <i>Window handle with DK movement</i>	04	14,50	15,00	16,50	15,50
724	Cremonese con movimento gratz <i>Window handle with gratz movement</i>	02	19,00	19,50	21,50	20,00
725	Martellina q.7 <i>Window handle q.7 spindle</i>	02	19,00	19,50	21,50	20,00
727	Maniglia c/rosetta ovale 32x62 coprivite a pressione e bocchetta foro chiave yale <i>Handle on oval rose with escutcheon</i>	02	22,50	23,50	25,50	24,00

art. 852

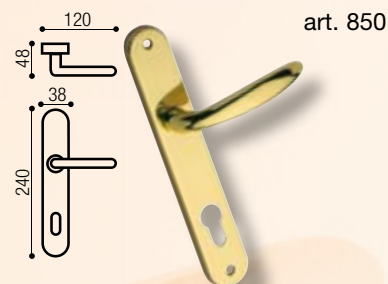
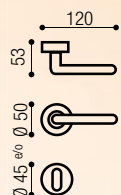

art. 850

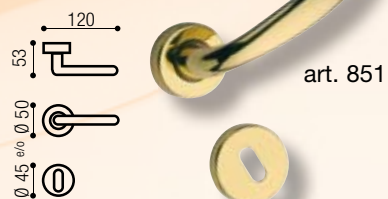

art. 851

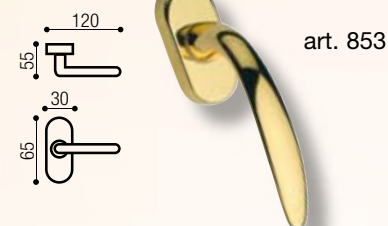

art. 853

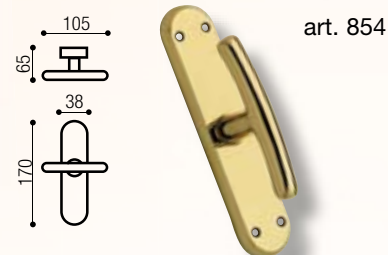

art. 854

Prezzi in € - Price in €

ART.	DESCRIZIONE	CONF. PEZZI	Z/OTT	Z/BG	Z/CS
850	Maniglia con placca e due molle (placca 03 mm. 240x38) vedi pag. 187 <i>Handle on plate and two springs, look on page 187</i>	01	27,00	28,00	29,00
851	Maniglia c/rosetta Ø45 a pressione e bocchetta foro chiave <i>Handle on rose Ø45 with escutcheon</i>	02	20,50	22,50	21,50
852	Maniglia c/rosetta Ø50 ad avvitare e bocchetta foro chiave <i>Handle on rose Ø50 to screw with escutcheon</i>	01	33,00	36,00	36,00
853	Martellina dry keep q.7 <i>Window handle with DK movement</i>	04	15,00	15,50	15,50
854	Cremonese con movimento gratz <i>Window handle with gratz movement</i>	02	19,00	19,50	20,00
855	Martellina q.7 <i>Window handle q.7 spindle</i>	02	19,00	19,50	20,00
857	Maniglia c/rosetta ovale 32x62 coprivite a pressione e bocchetta foro chiave yale <i>Handle on oval rose with escutcheon</i>	02	22,00	23,00	23,50



art. 932

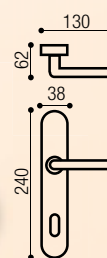
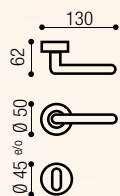

art. 930

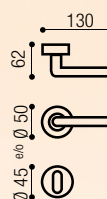

art. 931

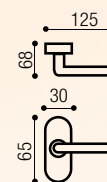

art. 933

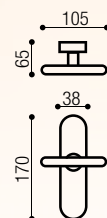

art. 934



Prezzi in € - Price in €

ART.	DESCRIZIONE	CONF. PEZZI	OLV	OBG	OCS
930.03	Coppia maniglia assemblata su placca seri (pl. 03 mm 240x38) vedi pag. 187 <i>Handle on plate and two springs, look on page 187</i>	01	30,00	31,00	33,00
931	Coppia maniglia c/rosetta Ø45 a pressione e bocchetta foro chiave <i>Handle on rose Ø45 with escutcheon</i>	02	24,00	25,50	26,50
932	Coppia maniglia c/rosetta Ø50 ad avvitare e bocchetta foro chiave <i>Handle on rose Ø50 to screw with escutcheon</i>	01	37,00	40,00	41,50
933	Martellina dry keep q.7 <i>Window handle with DK movement</i>	04	15,80	16,80	17,80
934	Cremonese con movimento gratz <i>Window handle with gratz movement</i>	02	19,00	19,50	20,00
935	Martellina q.7 <i>Window handle q.7 spindle</i>	02	19,00	19,50	20,00
937	Coppia maniglia c/rosetta ovale 32x62, coprivite a pressione e bocchetta foro chiave yale <i>Handle on oval rose with escutcheon</i>	02	25,50	27,00	28,00

art. 2182

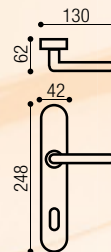
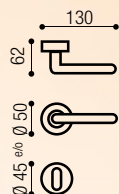

art. 2180.1

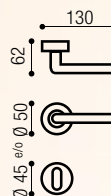

art. 2181

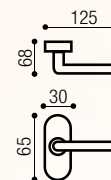

art. 2183



Prezzi in € - Price in €

ART.	DESCRIZIONE	CONF.	OLV/OSV	OCR/OCS
		PEZZI		
2180	Coppia maniglia con placca e due molle (placca 01 mm 248 x 42) vedi pag. 187 <i>Door handle on plate and two springs, look on page 187</i>	01	43,50	43,50
2181	Coppia maniglia c/rosetta Ø45 a pressione e bocchetta foro chiave <i>Handle on rose Ø45 with escutcheon</i>	01	36,00	36,00
2182	Kit Coppia maniglia c/rosetta Ø50 ad avvitare e bocchetta foro chiave <i>Handle on rose Ø50 to screw with escutcheon</i>	01	48,00	48,00
2183	Martellina dry keep q.7 <i>Window handle with DK movement</i>	04	21,50	21,50
2184	Cremonese impugn. maniglia con movimento gratz <i>Window handle with handle impugnation</i>	02	24,50	24,50
2185	Martellina q.7 impugnatura a maniglia <i>Window handle q.7 spindle without movement</i>	02	24,50	24,50

art. 2232

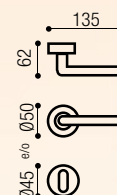
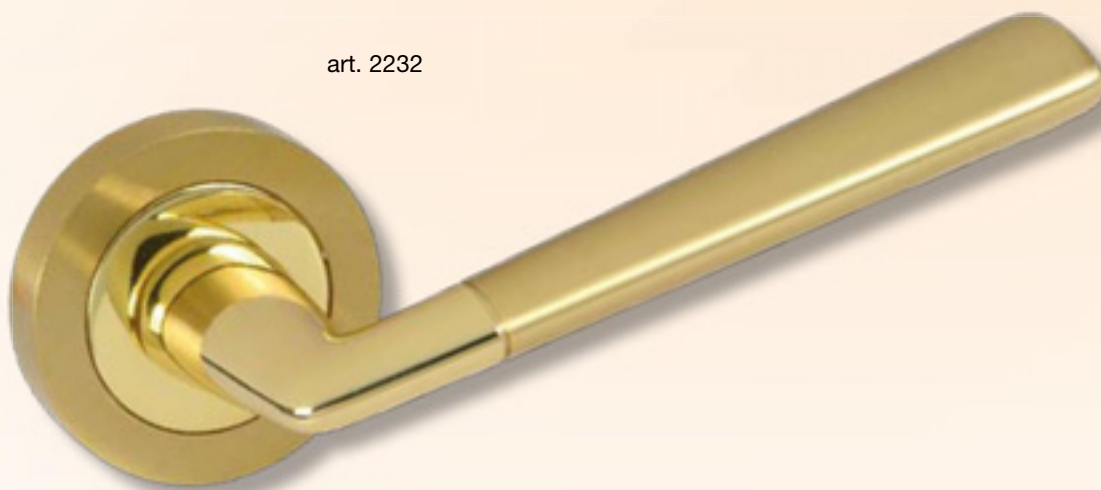

Prezzi in € - Price in €

ART.	DESCRIZIONE	CONF.	OLV/OSV	OCR/OCS	PEZZI
2220	Coppia maniglia assemblata su placca e due molle (placca 03 mm 240x38) vedi a pag. 187 <i>Handles on plate and two springs, look on page 187</i>	02	44,50	47,50	
2221	Coppia maniglia c/rosetta Ø45 a pressione e bocchetta foro chiave <i>Handles on rose Ø45 with escutcheon</i>	02	38,80	41,00	
2222	Coppia maniglia c/rosetta Ø50 ad avvitare e bocchetta foro chiave <i>Handles on rose Ø50 to screw with escutcheon</i>	01	51,00	55,00	
2223	Martellina dry keep q.7 <i>Window handles with DK movement</i>	04	22,00	23,00	
2224	Cremonese impugn. maniglia con movimento gratz <i>Window handles with handle impugnation</i>	02	34,00	34,00	
2225	Martellina q.7 impugnatura a maniglia <i>Window handles without movement q.7 spindle</i>	02	34,00	34,00	

MOON
art. 2272

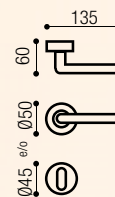

LUDMILLA
art. 2281

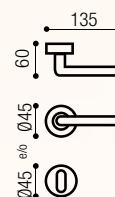

Prezzi in € - Price in €

ART.	DESCRIZIONE	CONF. PEZZI	OLV	OCS
MOON				
2270	Coppia maniglia con placca e due molle (pl. 03 mm 240x38) vedi pag. 187 <i>Handles on plate and two springs, look on page 187</i>	01	39,90	42,50
2271	Coppia maniglia c/rosetta Ø45 a pressione e bocchetta foro chiave <i>Handles on rose Ø45 with escutcheon</i>	02	34,30	36,30
2272	Coppia maniglia c/rosetta Ø50 ad avvitare e bocchetta foro chiave <i>Handles on rose Ø50 to screw with escutcheon</i>	01	47,00	49,00
2273	Martellina dry keep q.7 <i>Window handles with DK movement</i>	04	20,00	21,00
LUDMILLA				
2280	Coppia maniglia assemblata su placca e due molle (pl. 03 mm 240x38) vedi pag. 187 <i>Handles on plate and two springs, look on page 187</i>	01	35,50	37,90
2281	Coppia maniglia con rosetta Ø45 a pressione e bocchetta foro chiave <i>Handles on rose Ø45 with escutcheon</i>	02	29,50	31,50
2282	Coppia maniglia con rosetta Ø50 ad avvitare e bocchetta foro chiave <i>Handles on rose Ø50 to screw with escutcheon</i>	01	43,00	46,00
2223	Martellina q.7 movimento dry keep a 4 scatti <i>Window handle dry keep with mechanism 4 clicks</i>	04	18,50	19,50



art. 2342

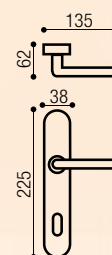
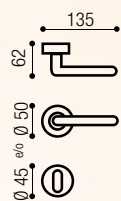

art. 2340

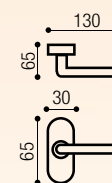

art. 2343

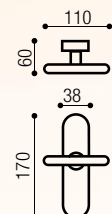

art. 2344

Prezzi in € - Price in €

ART.	DESCRIZIONE	CONF. PEZZI	OLV	OCS
2340	Coppia maniglia assemblata su placca e due molle (pl. 03 mm 240x38) vedi a pag. 187 <i>Handles on plate and two springs, look on page 187</i>	01	39,00	42,50
2341	Coppia maniglia con rosetta Ø45 a pressione e bocchetta foro chiave <i>Handles on rose Ø45 screw cover at pressure and escutcheon</i>	02	33,50	36,50
2342	Coppia maniglia con rosetta Ø50 ad avvitare e bocchetta foro chiave <i>Handles on rose Ø50 to screw with escutcheon</i>	01	46,90	50,90
2343	Martellina q.7 movimento dry keep a 4 scatti. <i>Window handle dry keep with mechanism 4 clicks</i>	04	19,00	20,50
2344	cremonese con movimento gratz <i>Window handles with gratz movement</i>	02	19,50	20,50
2345	Martellina q.7 <i>Window handles q.7 spindle</i>	02	19,50	20,50
2347	Coppia maniglia c/rosetta ovale 32x62 copriv. a pressione e bocchetta foro chiave yale <i>Handles on oval rose with escutcheon cylinder key hole</i>	02	35,00	38,00

art. 982

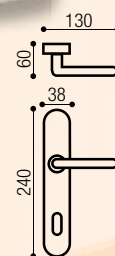
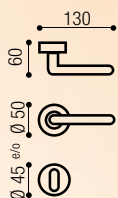

art. 980

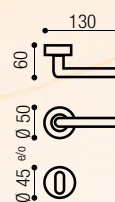
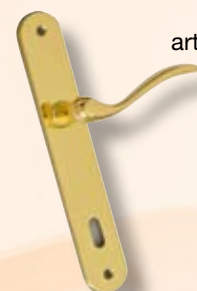

art. 981

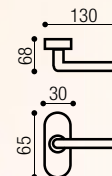
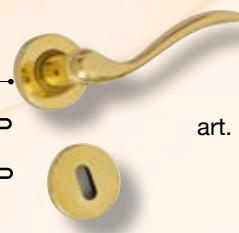

art. 983

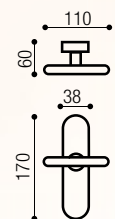

art. 984

Prezzi in € - Price in €

ART.	DESCRIZIONE	CONF. PEZZI	Z/OTT	Z/BG	Z/CS
980	Maniglia con placca e due molle <i>Handle on plate and two springs</i>	01	28,00	29,00	29,00
981	Maniglia c/rosetta Ø45 a pressione e bocchetta foro chiave <i>Handle on rose Ø45 with escutcheon</i>	02	21,50	23,50	22,50
982	Maniglia c/rosetta Ø50 ad avvitare e bocchetta foro chiave <i>Handle on rose Ø50 to screw with escutcheon</i>	01	34,50	37,50	36,50
983	Martellina dry keep q.7 <i>Window handle with DK movement</i>	04	16,00	16,50	16,50
984	Cremonese con movimento gratz <i>Window handle with gratz movement</i>	02	19,50	20,00	20,50
985	Martellina q.7 <i>Window handle q.7 spindle</i>	02	19,50	20,00	20,50
987	Maniglia c/rosetta ovale 32x62 coprivite a pressione e bocchetta foro chiave yale <i>Handle on oval rose with escutcheon</i>	02	24,00	26,00	25,00

art. 912

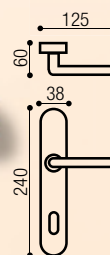
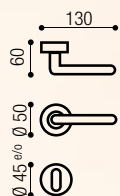

art. 910

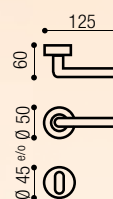

art. 911

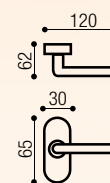

art. 913

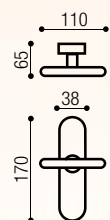

art. 914

Prezzi in € - Price in €

ART.	DESCRIZIONE	CONF. PEZZI	OLV	OBG	OCS	OSV
910	Coppia maniglia assemblata su placca (pl. 03 mm 240x38) vedi pag. 187 <i>Handle on plate and two springs, look on page 187</i>	01	30,50	31,50	33,00	
911	Coppia maniglia c/rosetta Ø45 a pressione e bocchetta foro chiave <i>Handle on rose Ø45 with escutcheon</i>	02	24,50	26,00	27,50	26,00
912	Kit Coppia maniglia c/rosetta Ø50 ad avvitare e bocchetta foro chiave <i>Handle on rose Ø50 to screw with escutcheon</i>	01	37,50	40,00	41,50	
913	Martellina dry keep q.7 <i>Window handle with DK movement</i>	04	15,50	16,50	17,00	16,50
914	Cremonese con movimento gratz <i>Window handle with gratz movement</i>	02	19,50	20,00	20,50	20,50
915	Martellina q.7 <i>Window handle q.7 spindle</i>	02	19,50	20,00	20,50	20,50
917	Coppia maniglia c/rosetta ovale 32x62, coprivite a pressione e bocchetta foro chiave yale <i>Handle on oval rose with escutcheon</i>	02	26,00	27,50	29,00	27,50

art. 170

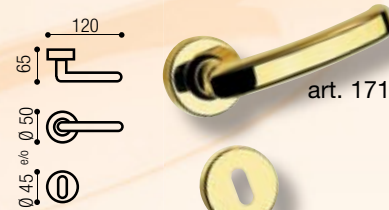
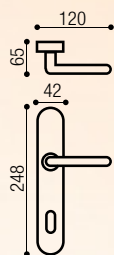
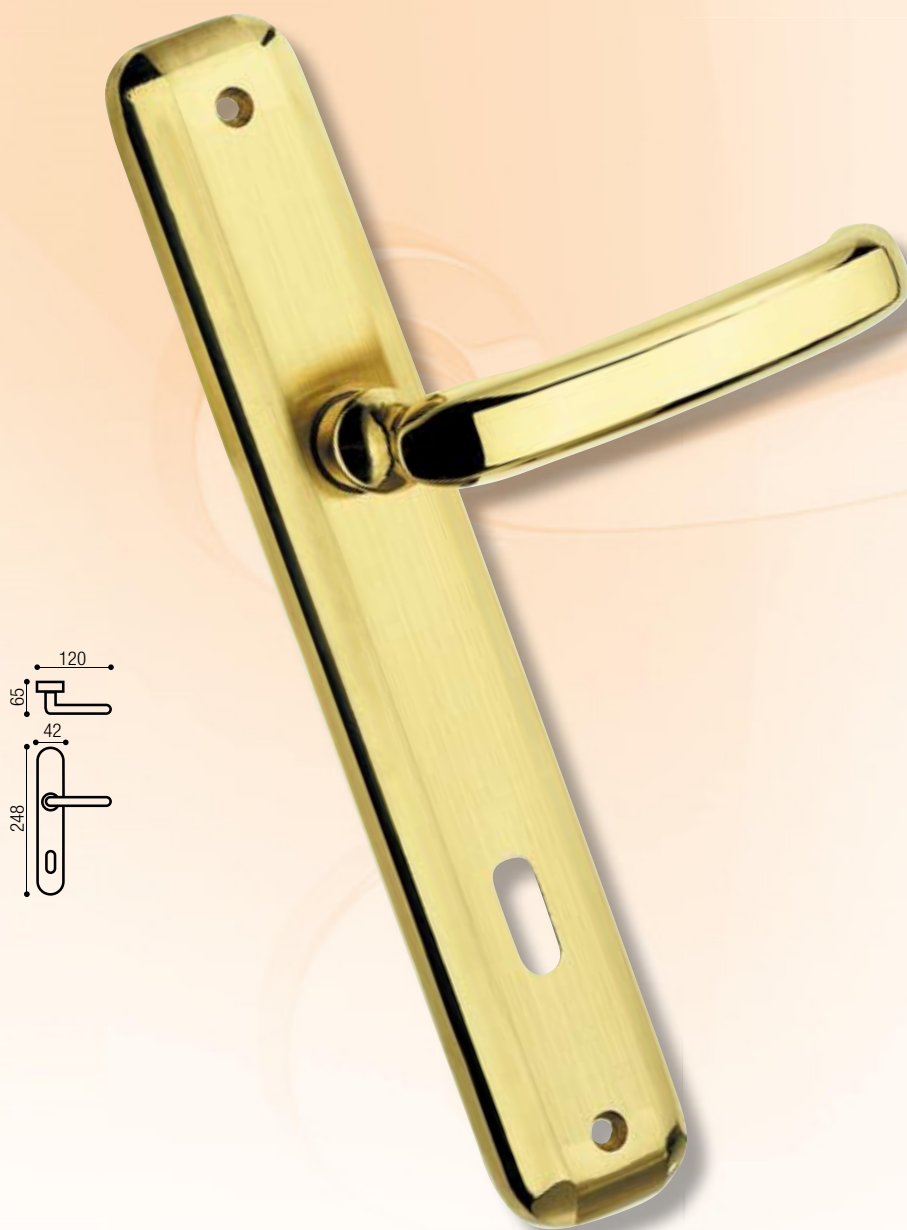

art. 171

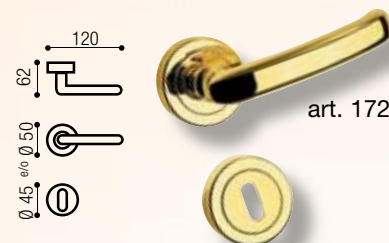

art. 172

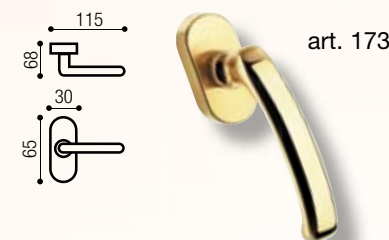

art. 173

Prezzi in € - Price in €

ART.	DESCRIZIONE	CONF. PEZZI	OLS	FUMÈ
170	Coppia maniglia con placca e due molle <i>Handle on plate and two springs</i>	02	37,50	40,50
171	Coppia maniglia c/rosetta Ø45 a pressione e bocchetta foro chiave <i>Handle on rose Ø45 with escutcheon</i>	02	27,00	
172	Coppia maniglia c/rosetta Ø50 ad avvitare e bocchetta foro chiave <i>Handle on rose Ø50 to screw with escutcheon</i>	01	40,50	
173	Martellina dry keep q.7 <i>Window handle with DK movement</i>	04	17,00	
176	Cremonese impugnatura maniglia mov. gratz <i>Window handle q.7 spindle</i>	02	24,00	25,00



art. 180

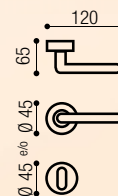

art. 181

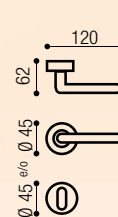

art. 182

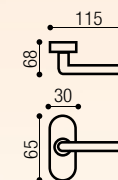

art. 183

Prezzi in € - Price in €

ART.	DESCRIZIONE	CONF. PEZZI	OLV	OLS	OBG	OCS
180	Coppia maniglia con placca e due molle (assemblata su placca 03) vedi pag. 187 <i>Handle on plate and two springs, look on page 187</i>	02	32,00	33,00	33,00	34,00
181	Coppia maniglia c/rosetta Ø45 a pressione e bocchetta foro chiave <i>Handle on rose Ø45 with escutcheon</i>	02	27,00	28,00	28,00	29,00
182	Coppia maniglia c/rosetta Ø50 ad avvitare e bocchetta foro chiave <i>Handle on rose Ø50 to screw with escutcheon</i>	01	40,50	42,50	42,50	43,50
183	Martellina dry keep q.7 <i>Window handle with DK movement</i>	04	17,00	18,00	18,00	21,50
186	Cremonese con impugnatura maniglia mov. gratz <i>Window handle q.7 spindle</i>	02	23,00	24,00	24,00	25,00
187	Coppia maniglia con rosetta ovale stretta 32x62 e bocchetta foro chiave yale <i>Handle on plate 225x27 without springs cylinder key hole</i>	02	28,50		29,50	30,50



art. 572

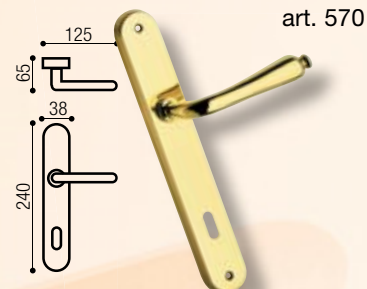
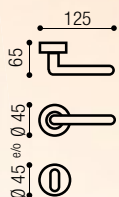

art. 570

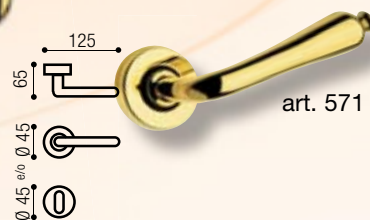

art. 571

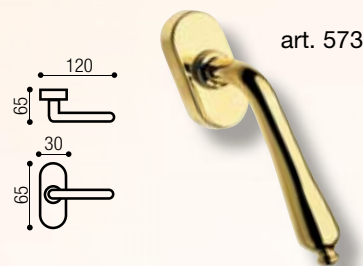

art. 573

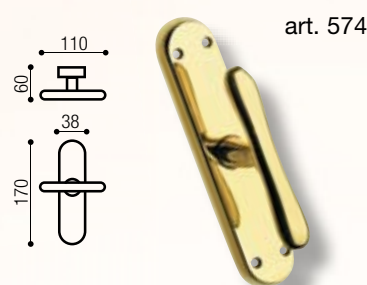

art. 574

Prezzi in € - Price in €

ART.	DESCRIZIONE	CONF. PEZZI	OLV	B/ANT	B/INV
570	Maniglia con placca e due molle <i>Handle on plate and two springs</i>	01	36,80	37,80	37,80
571	Maniglia c/rosetta Ø45 a pressione e bocchetta foro chiave <i>Handle on rose Ø45 with escutcheon</i>	02	31,00	34,00	34,00
572	Maniglia c/rosetta Ø50 ad avvitare e bocchetta foro chiave <i>Handle on rose Ø50 to screw with escutcheon</i>	01	42,50	45,50	45,50
573	Martellina dry keep q.7 <i>Window handle with DK movement</i>	04	18,50	20,50	20,50
574	Cremonese con movimento gratz <i>Window handle with gratz movement</i>	02	19,50	21,00	21,00
575	Martellina q.7 <i>Window handle q.7 spindle</i>	02	19,50	21,00	21,00

art. 150

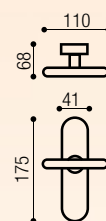
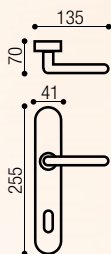
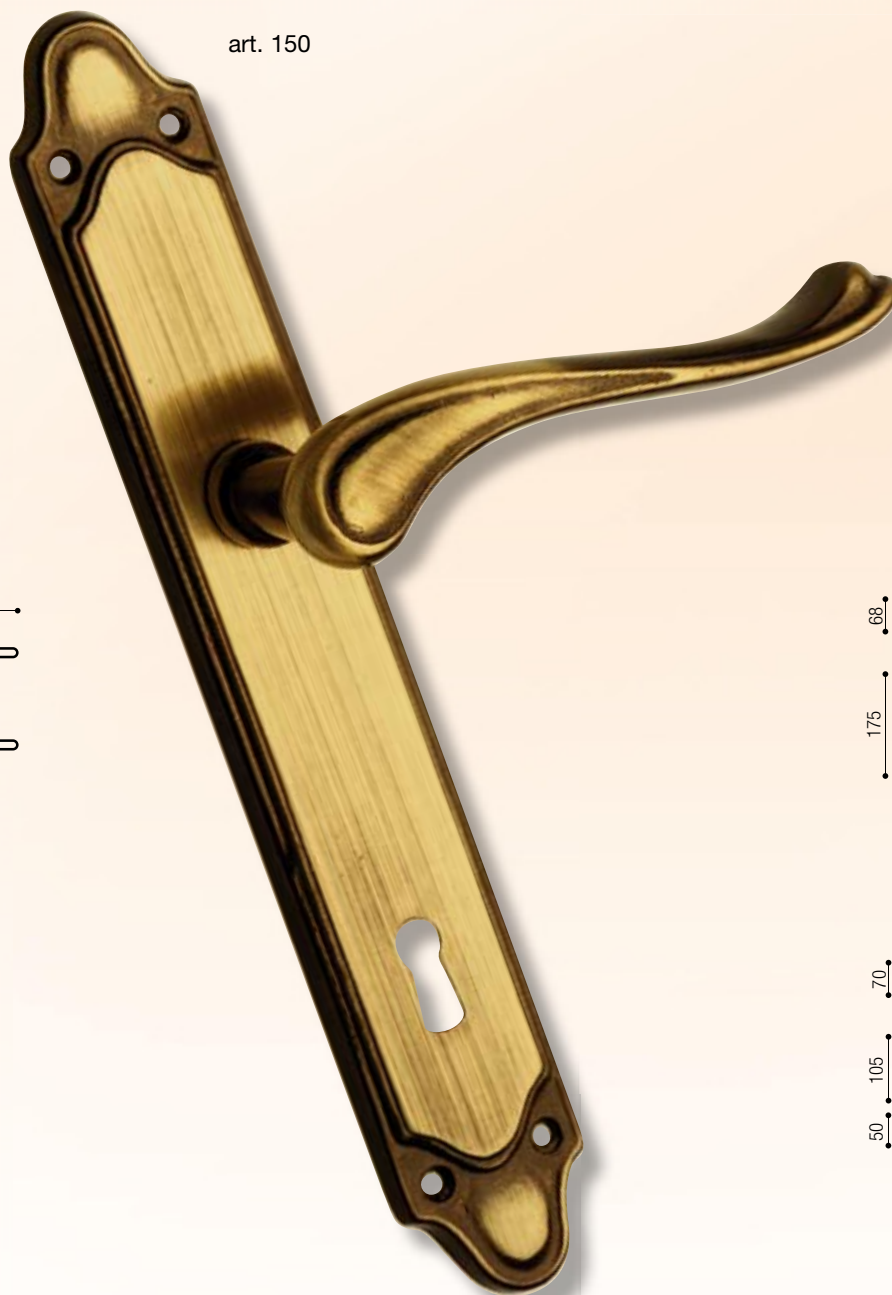

art. 154

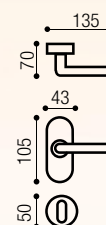

art. 157

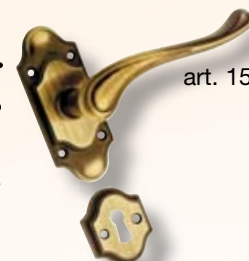

Prezzi in € - Price in €

ART.	DESCRIZIONE	CONF. PEZZI	OBG
150	Coppia maniglia con placca e due molle <i>Handle on plate and two springs</i>	04	30,20
151	Coppia maniglia c/rosetta Ø45 a pressione e bocchetta foro chiave <i>Handle on rose Ø45 with escutcheon</i>	02	26,40
152	Coppia maniglia c/rosetta Ø50 ad avvitare e bocchetta foro chiave <i>Handle on rose Ø50 to screw with escutcheon</i>	01	40,40
153	Martellina dry keep q.7 <i>Window handle with DK movement</i>	04	16,00
154	Cremonese con movimento gratz <i>Window handle with gratz movement</i>	02	19,20
155	Martellina q.7 <i>Window handle q.7 spindle</i>	02	19,20
157	Coppia maniglia c/rosetta in stile 105x43 e bocchetta foro chiave (senza molla) <i>Handle on rose in style with escutcheon</i>	02	38,00

art. 2252

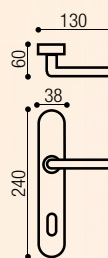
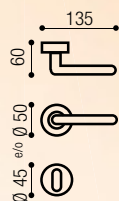

art. 2250

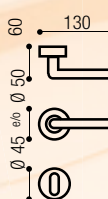

art. 2251

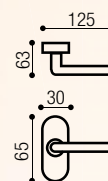

art. 2253

art. 2258

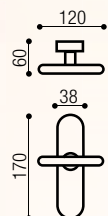
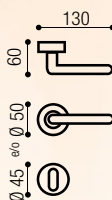

art. 2254

Prezzi in € - Price in €

ART.	DESCRIZIONE	CONF. PEZZI	OLV	B/ANT	B/INV	OCS
2250	Coppia maniglia assemblata su placca (assemblata su placca 03) vedi pag. 187 <i>Handles on plate and two springs, look on page 187</i>	01	41,00	42,00	42,00	
2251	Coppia maniglia c/rosetta Ø45 a pressione e bocchetta foro chiave <i>Handle on rose Ø45 with escutcheon</i>	02	34,50	36,50	36,50	38,50
2252	Coppia maniglia c/rosetta Ø50 ad avvitare e bocchetta foro chiave <i>Handle on rose Ø50 to screw with escutcheon</i>	01	49,50	51,00	51,00	53,00
2253	Martellina dry keep q.7 <i>Window handle with DK movement</i>	04	21,50	22,50	22,50	23,50
2254	Cremonese con movimento gratz <i>Window handle with gratz movement</i>	02	19,50	21,00	21,00	20,50
2255	Martellina q.7 <i>Window handle q.7 spindle</i>	02	19,50	21,00	21,00	20,50
2256	Cremonese impugnatura a maniglia mov. gratz <i>Window handle with handle impugnation</i>	02	27,50	29,00	29,00	28,50
2258	Coppia maniglia c/rosetta Ø45x9 c. fori in vista e bocchetta foro chiave patent (senza molla) <i>Handle on rose Ø45 with escutcheon without spring</i>	01	48,00	50,00	50,00	52,00

art. 2248

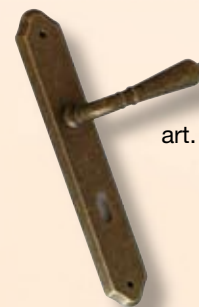
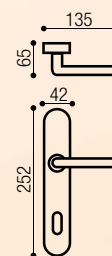
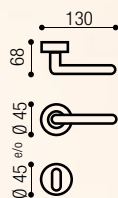

art. 2240

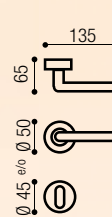

art. 2242

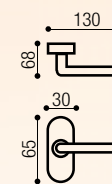

art. 2243

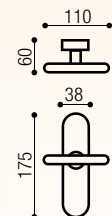

art. 2244

Prezzi in € - Price in €

ART.	DESCRIZIONE	CONF. PEZZI	OLV	OBG	B/INV
2240.5	Coppia maniglia assemblata su placca e due molle (assemblata con placca n. 05) vedi pag. 187 <i>Handles on plate and two springs, look on page 187</i>	01	44,00	45,00	47,00
2241	Coppia maniglia c/rosetta Ø45 a pressione e bocchetta foro chiave <i>Handle on rose Ø45 with escutcheon</i>	02	31,00	32,00	34,00
2242	Coppia maniglia c/rosetta Ø50 ad avvitare e bocchetta foro chiave <i>Handle on rose Ø50 to screw with escutcheon</i>	01	42,50	44,50	45,50
2243	Martellina dry keep q.7 <i>Window handle with DK movement</i>	04	18,50	19,50	20,50
2244	Cremonese con movimento gratz <i>Window handle with gratz movement</i>	02	25,80	26,80	27,50
2245	Martellina q.7 <i>Window handle q.7 spindle</i>	02	25,80	26,80	27,50
2248	Coppia maniglia c/rosetta Ø45x9 c. fori in vista e bocchetta foro chiave patent (senza molla) <i>Handle on rose Ø45 with escutcheon without spring</i>	01	41,00	42,50	43,50

art. 2808

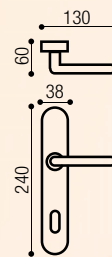
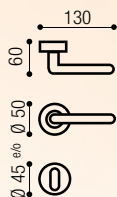

art. 2800

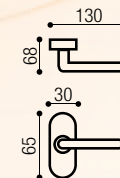

art. 2803

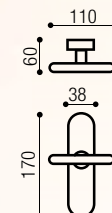

art. 2804

Prezzi in € - Price in €

ART.	DESCRIZIONE	CONF. PEZZI	OLV	B/INV
2800	Coppia maniglia con placca e due molle (assemblata su placca 01) vedi pag. 187 <i>Handle on plate and two springs, look on page 187</i>	01	41,50	42,50
2802	Coppia maniglia c/rosetta Ø50 ad avvitare e bocchetta foro chiave <i>Handle on rose Ø50 to screw with escut.</i>	01	46,50	47,50
2803	Martellina dry keep q.7 <i>Window handle with DK movement</i>	04	21,00	22,00
2804	Cremonese con movimento gratz <i>Window handle with gratz movement</i>	02	24,00	25,00
2805	Martellina con ferro q.7 a sfilare <i>Window handle q.7 square spindle</i>	02	24,00	25,00
2808	Coppia maniglia c/rosetta Ø45 con fori vite in vista /senza molla e bocchetta foro chiave <i>Handle on rose Ø45 without spring with escutcheon</i>	01	44,50	45,50

art. 2818

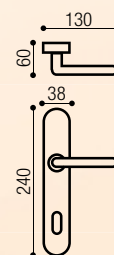
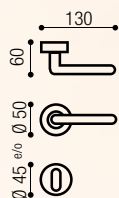

art. 2810

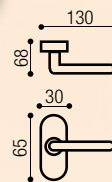

art. 2812

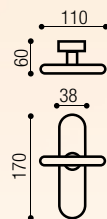

art. 2814



art. 1291



Prezzi in € - Price in €

ART.	DESCRIZIONE	CONF. PEZZI	OLV	B/INV
2810	Coppia maniglia con placca e due molle (assemblata su placca 03) vedi pag. 187 <i>Handle on plate and two springs, look on page 187</i>	01	37,50	38,50
2811	Coppia maniglia c/rosetta Ø45 a pressione bocchetta foro chiave <i>Handle on rose Ø45 screw cover at pre pressure with escutcheon</i>	02	31,50	32,50
2812	Coppia maniglia c/rosetta Ø50 ad avvitare e bocchetta foro chiave <i>Handle on rose Ø50 to screw with escut.</i>	01	44,00	45,00
2813	Martellina dry keep q.7 <i>Window handle with DK movement</i>	04	19,70	20,70
2814	Cremonese con movimento gratz <i>Window handle with gratz movement</i>	02	21,50	22,50
2815	Martellina con ferro q.7 a sfilare <i>Window handle q.7 square spindle</i>	02	21,50	22,50
2818	Coppia maniglia c/rosetta Ø45 con fori vite in vista/senza molla) e bocchetta foro chiave <i>Handle on rose Ø45 without spring with escutcheon</i>	01	41,50	42,50
1291	Segretino q.7 con rosetta ovale e viti a vista <i>Handles on plate q.7</i>	06	16,90	

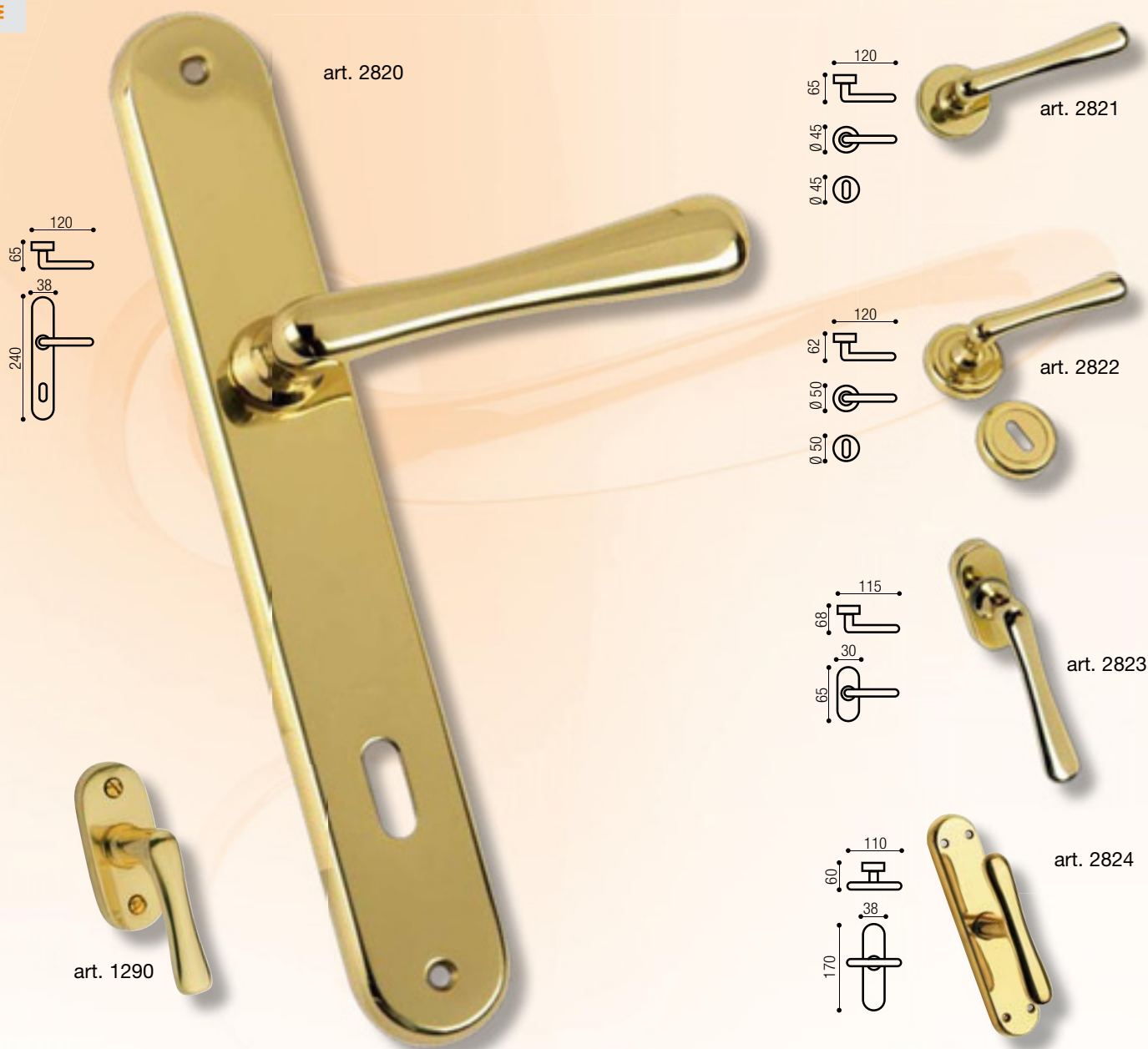

art. 2820

art. 2821

art. 2822

art. 2823

art. 2824

art. 1290

Prezzi in € - Price in €

ART.	DESCRIZIONE	CONF. PEZZI	OLV	OBG	OCS
2820	Coppia maniglia con placca e due molle (assemblata su placca 03) vedi pag. 187 <i>Handle on plate and two springs, look on page 187</i>	01	30,50	32,00	37,50
2821	Coppia maniglia c/rosetta Ø45 a pressione bocchetta foro chiave <i>Handle on rose Ø45 screw cover at pre pressure with escutcheon</i>	02	27,60	29,20	35,50
2822	Coppia maniglia c/rosetta Ø50 ad avvitare e bocchetta foro chiave <i>Handle on rose Ø50 to screw with escut.</i>	01	36,40	36,80	43,00
2823	Martellina dry keep q.7 <i>Window handle with DK movement</i>	04	18,90	20,50	22,00
2824	Cremonese con movimento gratz <i>Window handle with gratz movement</i>	02	19,50	20,00	20,50
2825	Martellina con ferro q.7 a sfilare <i>Window handle q.7 square spindle</i>	02	19,50	20,00	20,50
1290	Segretino q.7 con rosetta ovale e viti a vista <i>Handles on plate q.7</i>	06	16,90	18,60	21,70

art. 802

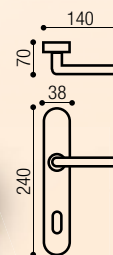
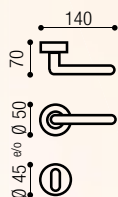

art. 800

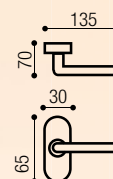

art. 803

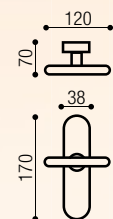

art. 804

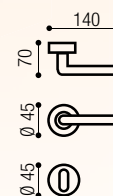

art. 808

PORCELLANA CHAMPAGNE E FIORE ROSA / FLOWER ROSE DEC. CHAMPAGNE PORCELAIN

Prezzi in € - Price in €

ART.	DESCRIZIONE	CONF. PEZZI	OLV	B/ANT	B/INV
800	Coppia maniglia assemblata su placca con due molle <i>Handles on plate and two springs</i>	01	58,50	59,50	59,50
801	Coppia maniglia c/rosetta Ø45 a pressione e bocchetta foro chiave <i>Handles on rose Ø45 with escutcheon</i>	01	53,00	54,00	54,00
802	Coppia maniglia c/rosetta Ø50 ad avvitare e bocchetta foro chiave <i>Handles on rose Ø50 to screw with escutcheon</i>	01	67,50	68,50	68,50
803	Martellina dry keep q.7 <i>Window handle with DK movement</i>	02	31,00	31,50	31,50
804	Cremonese con movimento gratz <i>Window handles with gratz movement</i>	02	43,80	44,80	44,80
805	Martellina q.7 <i>Window handle q.7 spindle</i>	02	43,80	44,80	44,80
808	Coppia maniglia c/rosetta Ø45x9 c. fori in vista e bocchetta foro chiave patent (senza molla) <i>Handles on oval rose with escutcheon without spring</i>	01	63,50	64,50	64,50

art. 792

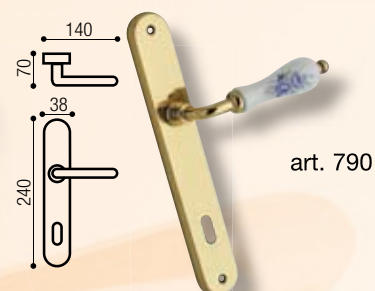
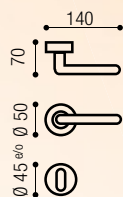
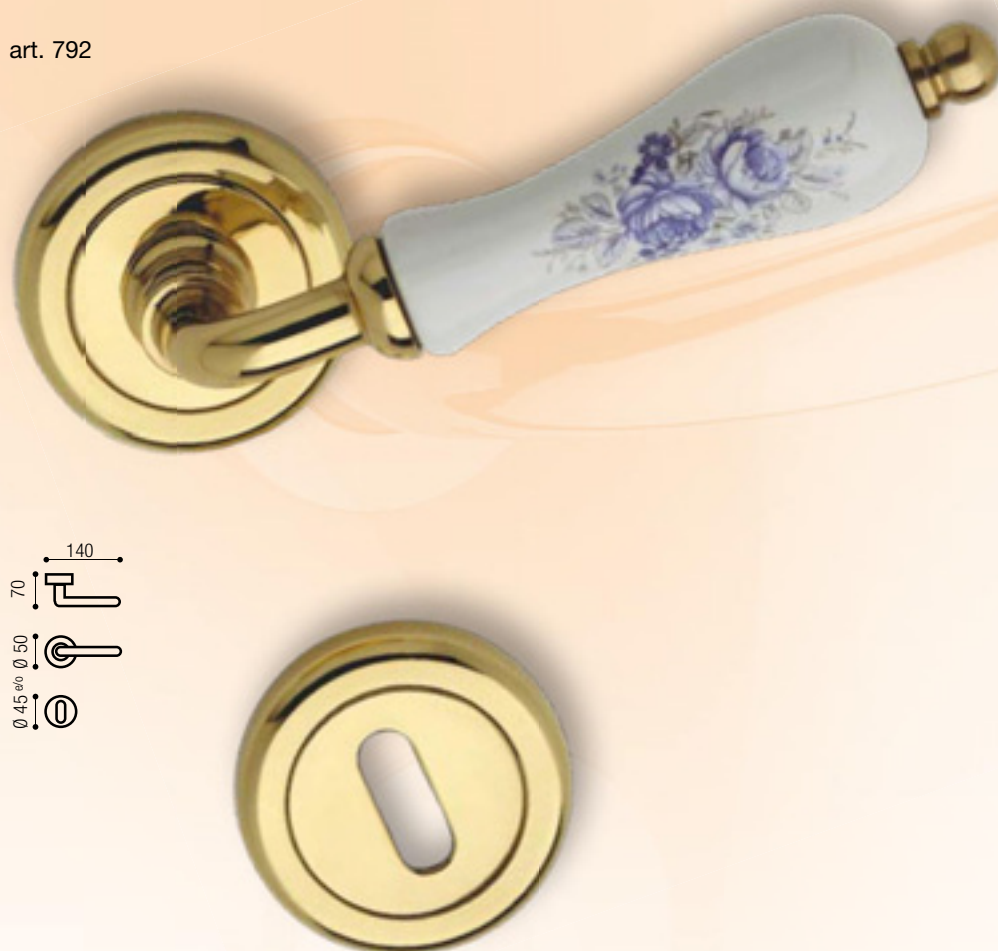

art. 790

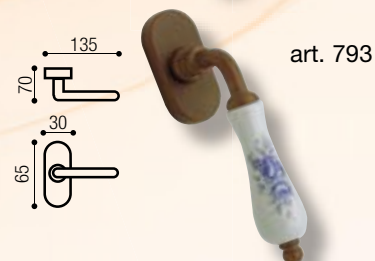
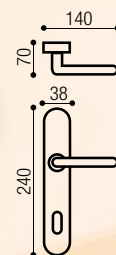

art. 793

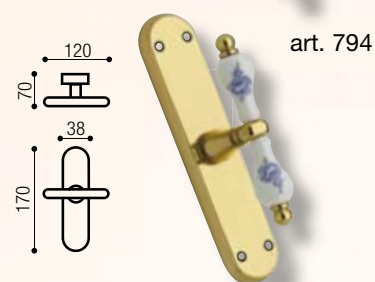
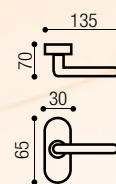

art. 794

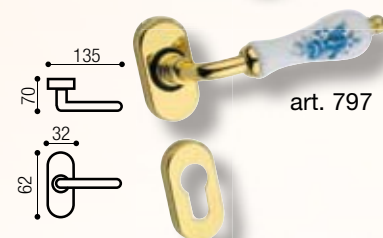
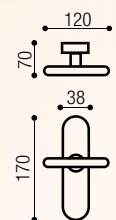

art. 797

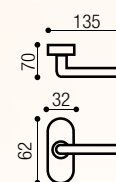

PORCELLANA BIANCA E FIORE BLU / FLOWER BLUE DEC. WHITE PORCELAIN

Prezzi in € - Price in €

ART.	DESCRIZIONE	CONF. PEZZI	OLV	B/ANT	B/INV
790	Coppia maniglia assemblata su placca con due molle <i>Handles on plate and two springs</i>	01	58,50	59,50	59,50
791	Coppia maniglia c/rosetta Ø 45 a pressione e bocchetta foro chiave <i>Handles on rose Ø 45 with escutcheon</i>	01	53,00	54,00	54,00
792	Coppia maniglia c/rosetta Ø 50 ad avvitare e bocchetta foro chiave <i>Handles on rose Ø 50 to screw with escutcheon</i>	01	67,50	68,50	68,50
793	Martellina dry keep q.7 <i>Window handle with DK movement</i>	02	31,00	31,50	31,50
794	Cremonese con movimento gratz <i>Window handles with gratz movement</i>	02	43,80	44,80	44,80
795	Martellina q.7 <i>Window handle q.7 spindle</i>	02	43,80	44,80	44,80
798	Coppia maniglia c/rosetta Ø 45x9 c. fori in vista e bocchetta foro chiave patent (senza molla) <i>Handles on rose Ø 45 with escutcheon without spring</i>	01	63,50	64,50	64,50

art. 782

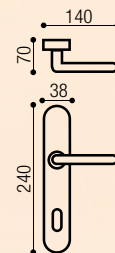

art. 780

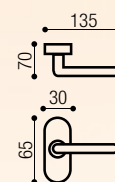
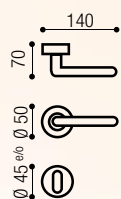

art. 783

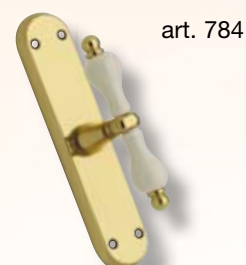
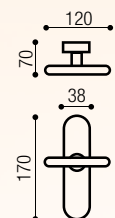

art. 784

PORCELLANA CHAMPAGNE / CHAMPAGNE PORCELAIN

Prezzi in € - Price in €

ART.	DESCRIZIONE	CONF. PEZZI	OLV	B/ANT	B/INV
780	Coppia maniglia assemblata su placca con due molle <i>Handles on plate and two springs</i>	01	51,00	52,00	52,00
781	Coppia maniglia c/rosetta Ø45 a pressione e bocchetta foro chiave <i>Handles on rose Ø45 with escutcheon</i>	01	46,00	47,00	47,00
782	Coppia maniglia c/rosetta Ø50 ad avvitare e bocchetta foro chiave <i>Handles on rose Ø50 to screw with escutcheon</i>	01	58,00	59,50	59,50
783	Martellina dry keep q.7 <i>Window handle with DK movement</i>	02	26,90	27,50	27,50
784	Cremonese con movimento gratz <i>Window handles with gratz movement</i>	02	38,50	39,50	39,50
785	Martellina q.7 <i>Window handle q.7 spindle</i>	02	38,50	39,50	39,50
788	Coppia maniglia c/rosetta Ø45x9 c. fori in vista e bocchetta foro chiave patent (senza molla) <i>Handles on rose Ø45 with escutcheon without spring</i>	01	55,50	56,50	56,50

art. 742

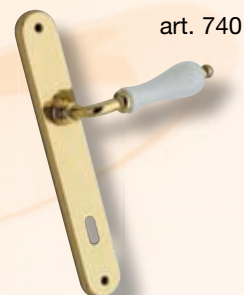
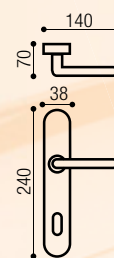
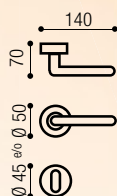

art. 740

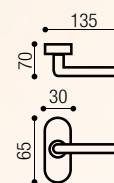

art. 743

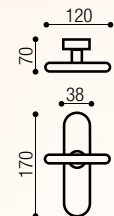

art. 744

PORCELLANA BIANCA / WHITE PORCELAIN

Prezzi in € - Price in €

ART.	DESCRIZIONE	CONF. PEZZI	OLV	B/ANT	B/INV
740	Coppia maniglia assemblata su placca con due molle <i>Handles on plate and two springs</i>	01	49,50	50,00	50,00
741	Coppia maniglia c/rosetta Ø45 a pressione e bocchetta foro chiave <i>Handles on rose Ø45 with escutcheon</i>	01	44,00	45,00	45,00
742	Coppia maniglia c/rosetta Ø50 ad avvitare e bocchetta foro chiave <i>Handles on rose Ø50 to screw with escutcheon</i>	01	56,50	58,50	58,50
743	Martellina dry keep q.7 <i>Window handle with DK movement</i>	02	25,90	26,50	26,50
744	Cremonese con movimento gratz <i>Window handles with gratz movement</i>	02	38,00	39,00	39,00
745	Martellina q.7 <i>Window handle q.7 spindle</i>	02	38,00	39,00	39,00
748	Coppia maniglia c/rosetta Ø45x9 c. fori in vista e bocchetta foro chiave patent (senza molla) <i>Handles on rose Ø45 with escutcheon without spring</i>	01	54,00	55,00	55,00

art. 828

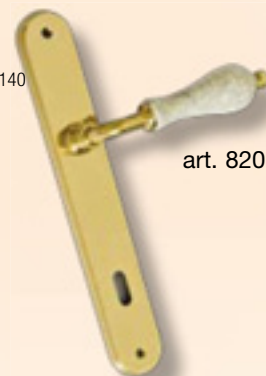
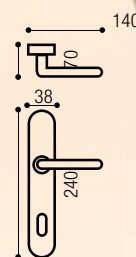
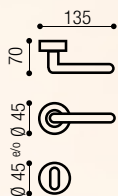

art. 820

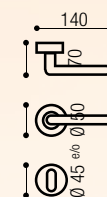

art. 822

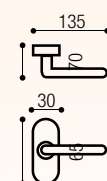

art. 823

PORCELLANA CHAMPAGNE / CHAMPAGNE PORCELAIN

Prezzi in € - Price in €

ART.	DESCRIZIONE	CONF. PEZZI	OLV	B/ANT	B/INV
820	Coppia maniglia assemblata su placca con due molle <i>Handles on plate and two springs</i>	02	53,00	54,00	54,00
821	Coppia maniglia c/rosetta Ø45 a pressione e bocchetta foro chiave <i>Handle on rose Ø45 with escutcheon</i>	01	48,00	49,00	49,00
822	Coppia maniglia c/rosetta Ø50 ad avvitare e bocchetta foro chiave <i>Handle on rose Ø50 to screw with escutcheon</i>	01	60,00	61,50	61,50
823	Martellina dry keep q.7 <i>Window handle with DK movement</i>	02	28,00	28,50	28,50
825	Cremonese impugnatura maniglia mov.gratz <i>Window handle with gratz movement</i>	02	40,50	41,50	41,50
826	Martellina impugnatura a maniglia q.7 <i>Window handles without movement q.7 spindle</i>	02	40,50	41,50	41,50
828	Coppia maniglia c/rosetta Ø45x9 c. fori in vista e bocchetta foro chiave patent (senza molla) <i>Handles on rose Ø45 with escutcheon without spring</i>	01	57,50	58,50	58,50

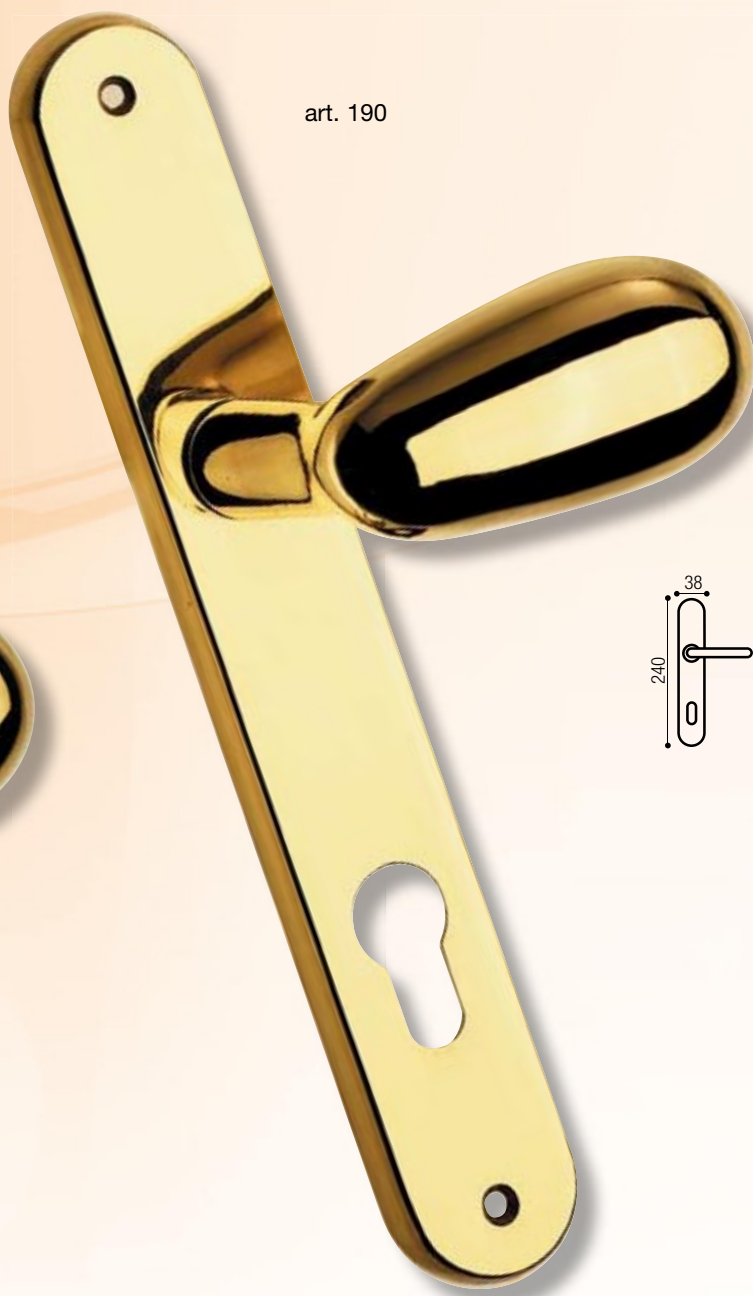

art. 190



art. 191

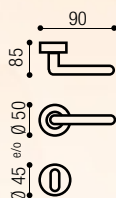
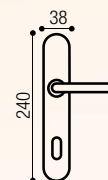

Prezzi in € - Price in €

ART.	DESCRIZIONE	CONF. PEZZI	OLV	OBG	OCR	OCS
190	Coppia maniglia con placca e due molle <i>Handle on plate and two springs</i>	01	60,80	61,50	67,00	66,00
191	Coppia maniglia c/rosetta Ø45 a pressione e bocchetta foro chiave <i>Handle on rose Ø45 with escutcheon</i>	01	54,80	55,60	61,50	60,50
192	Coppia maniglia c/rosetta Ø50 ad avvitare e bocchetta foro chiave <i>Handle on rose Ø50 to screw with escutcheon</i>	01	67,00	69,00	74,50	73,50
193	Martellina dry keep q.7 <i>Window handle with DK movement</i>	02	30,50	31,00	33,80	32,80
194	Coppia maniglia c/rosetta coprivite mm 32x62 a pressione e bocchetta foro chiave yale <i>Handle on oval rose with escutcheon</i>	02	56,50	57,00	63,00	62,00



Prezzi in € - Price in €

ART.	DESCRIZIONE	CONF. PEZZI	OLV	OBG	OCS	Z/CS
ZANCATO GAMMA						
280	Coppia pomolo zancato con placca e due molle <i>Handle on plate and two springs</i>	01	64,00	67,00	82,50	
281	Coppia pomolo zancato c/rosetta Ø45 a pressione e bocchetta foro chiave <i>Handle on rose Ø45 with escutcheon</i>	01	58,50	61,50	76,00	
282	Coppia pomolo zancato c/rosetta Ø50 ad avvitare e bocchetta foro chiave <i>Handle on rose Ø50 to screw with escutcheon</i>	01	71,00	75,00	90,50	
283	Coppia pomolo zancato c/ros. coprivate ovale mm 32x62 a pressione e bocchetta foro chiave yale <i>Handle on oval rose with escutcheon</i>	01	60,00	63,00	77,50	
DECENTRATO GAMMA						
390	Coppia pomolo decentrato con placca edue molle <i>Handle on plate and two springs</i>	01	60,80	61,50	72,50	
391	Coppia pomolo decentrato c/rosetta Ø45 a pressione e bocchetta foro chiave <i>Handle on rose Ø45 with escutcheon</i>	01	54,80	55,60	66,50	
392	Coppia pomolo decentrato c/rosetta Ø50 ad avvit. e bocchetta foro chiave <i>Handle on rose Ø50 to screw with escutcheon</i>	01	67,00	69,00	80,00	
393	Coppia pomolo decentrato c/ros.coprivate ovale mm 32x62 a pressione e bocchetta foro chiave yale <i>Handle on oval rose with escutcheon</i>	02	56,50	57,00	68,00	
POMOLO QUADRO ZANCATO						
395	Coppia pomolo zancato mm 55x55 con rosetta quadra mm 50x50 due molle e bocchetta foro chiave <i>Handle mm 55x55 on rose mm 50x50 and two springs escutcheon</i>	01				45,00
396	Coppia pomolo zancato mm 55x55 con rosetta rettangolare mm 65x33 due molle e bocchetta foro chiave <i>Handle mm 55x55 on rose mm 65x33 and two springs escutcheon</i>	01				45,00

art. 115



art. 119

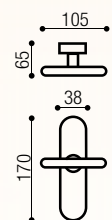
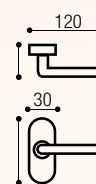
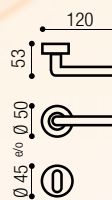
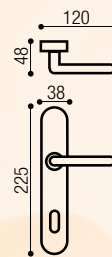

Prezzi in € - Price in €

ART.	DESCRIZIONE	CONF. PEZZI	OLV	FUMÈ
115	Maniglia con placca <i>Handle on plate</i>	01	25,00	26,50
116	Maniglia c/rosetta Ø45 a pressione e bocchetta foro chiave <i>Handle on rose Ø45 with escutcheon</i>	02	23,50	23,50
118	Martellina dry keep q.7 <i>Window handle with DK movement</i>	04	17,00	18,00
119	Cremonese con movimento gratz <i>Window handle with gratz movement</i>	02	16,50	17,50
120	Martellina q.7 <i>Window handle q.7 spindle</i>	02	16,50	17,50

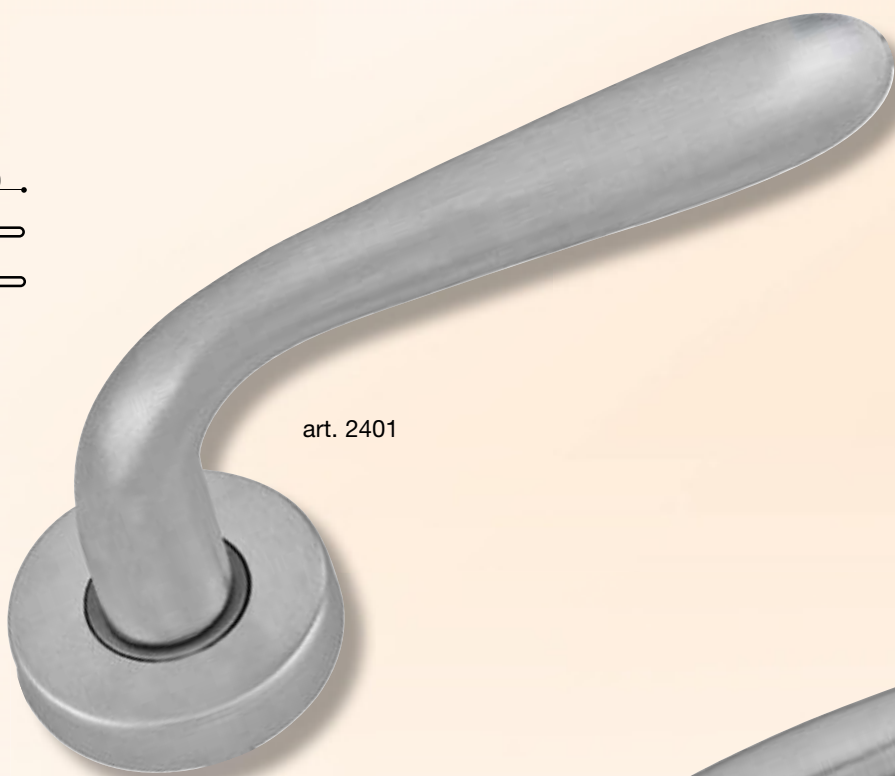
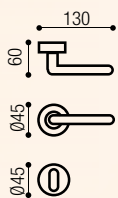

art. 2401

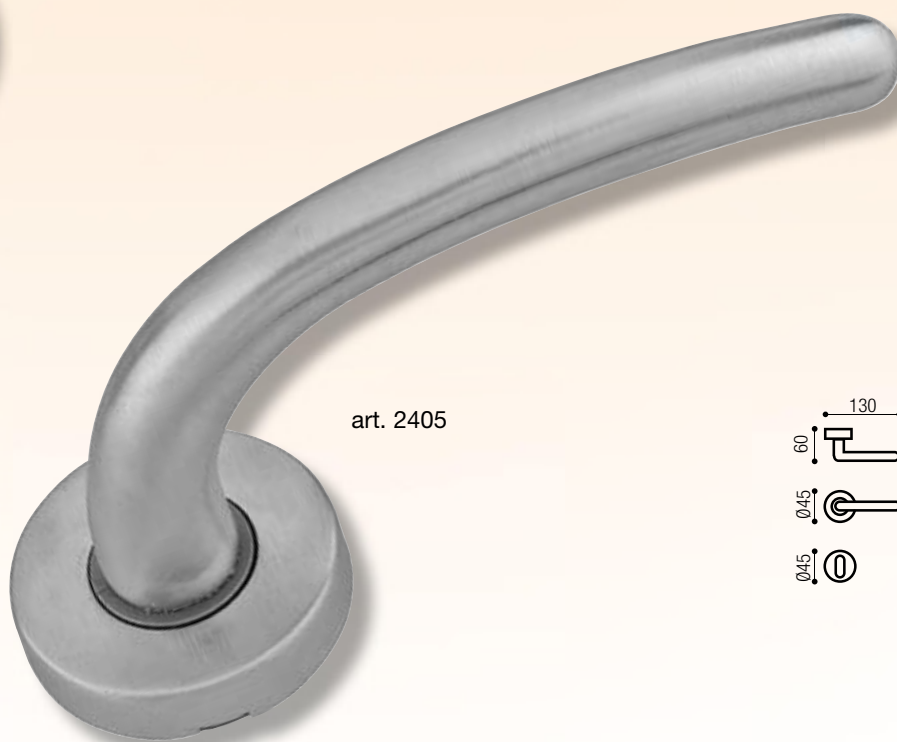

art. 2405

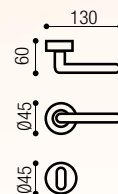

Prezzi in € - Price in €

ART.	DESCRIZIONE	CONF. PEZZI	Z/OTT	Z/CS
MIRAGE				
2401	Maniglia c/rosetta Ø45 a pressione e bocchetta foro chiave <i>Handles on rose Ø45 with escutcheon</i>	02	19,60	19,60
2403	Martellina dry keep q.7 <i>Window handle with DK movement</i>	04	14,65	14,65
ASTRAL				
2405	Maniglia c/rosetta Ø45 a pressione e bocchetta foro chiave <i>Handles on rose Ø45 with escutcheon</i>	02	19,30	19,30
2407	Martellina dry keep q.7 <i>Window handle with DK movement</i>	04	14,50	14,50

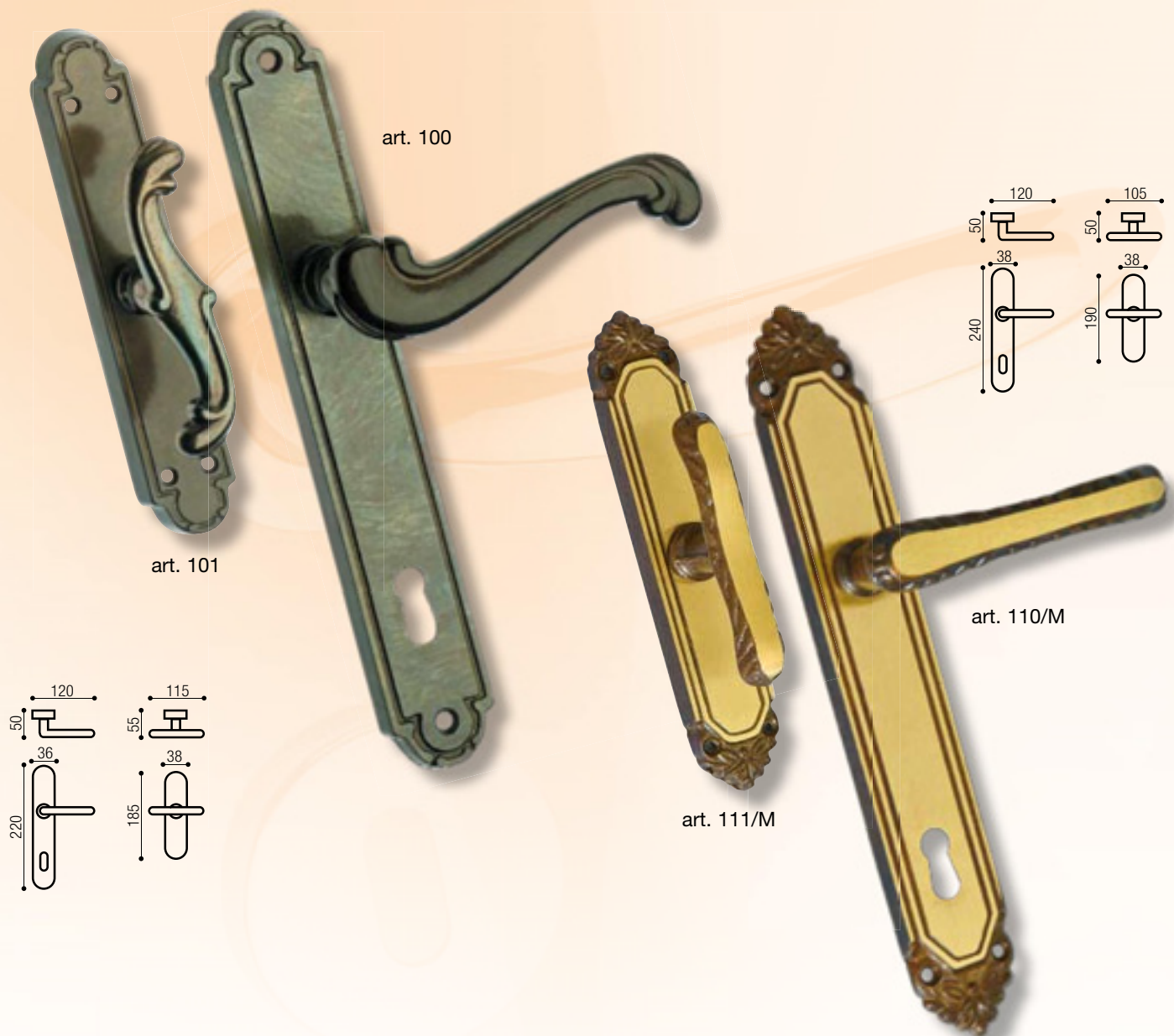

Prezzi in € - Price in €

ART.	DESCRIZIONE	CONF. PEZZI	OBV	FUMÈ
BAROCCO				
100	Coppia maniglia con placca senza molle <i>Handle on plate without springs</i>	06	17,90	
101	Cremonese con movimento gratz c. fori <i>Window handle with gratz movement</i>	10	13,80	
102	Martellina q.7 <i>Window handle without movement</i>	10	12,80	
ROSELLA-M				
110M	Coppia maniglia con placca e una molla <i>Handle on plate and two springs</i>	06		18,90
111M	Cremonese con movimento gratz c. fori <i>Window handle with gratz movement</i>	06		13,80
112M	Martellina q.7 <i>Window handle without movement</i>	06		12,80



BRISTOL
art. 1640



MONACO
art. 1650



OSLO
art. 1660



OSAKA
art. 1670

Prezzi in € - Price in €

ART.	DESCRIZIONE	CONF. PEZZI	INOX SAT
BRISTOL			
1640	Coppia maniglia c/rosetta Ø52 a pressione e bocchetta foro chiave <i>Handle on rose Ø52 at pressure and escutcheon key hole</i>	01	23,50
1642	Martellina dry keep q.7 <i>Window handle dry keep q.7</i>	04	15,50
MONACO			
1650	Coppia maniglia c/rosetta Ø52 a pressione e bocchetta foro chiave <i>Handle on rose Ø52 at pressure and escutcheon key hole</i>	01	23,50
1652	Martellina dry keep q.7 <i>Window handle dry keep q.7</i>	04	15,50
OSLO			
1660	Coppia maniglia c/rosetta Ø52 a pressione e bocchetta foro chiave <i>Handle on rose Ø52 at pressure and escutcheon key hole</i>	01	23,50
1662	Martellina dry keep q.7 <i>Window handle dry keep q.7</i>	04	15,50
OSAKA			
1670	Coppia maniglia c/rosetta Ø52 a pressione e bocchetta foro chiave <i>Handle on rose Ø52 at pressure and escutcheon key hole</i>	01	48,00
1671	Martellina dry keep q.7 <i>Window handle dry keep q.7</i>	04	24,00



DUBLINO
art. 1680



MILANO
art. 1690



MELBOURNE
art. 1700

Prezzi in € - Price in €

ART.	DESCRIZIONE	CONF. PEZZI	INOX SAT
DUBLINO			
1680	Coppia maniglia c/rosetta Ø52 a pressione e bocchetta foro chiave <i>Handle on rose Ø52 at pressure and escutcheon key hole</i>	01	56,00
1682	Martellina dry keep q.7 <i>Window handle dry keep q.7</i>	04	29,50
MILANO			
1690	Coppia maniglia c/rosetta Ø52 a pressione e bocchetta foro chiave <i>Handle on rose Ø52 at pressure and escutcheon key hole</i>	01	52,00
1692	Martellina dry keep q.7 <i>Window handle dry keep q.7</i>	04	26,50
MELBOURNE			
1700	Coppia maniglia c/rosetta Ø52 a pressione e bocchetta foro chiave <i>Handle on rose Ø52 at pressure and escutcheon key hole</i>	01	60,00
1702	Martellina dry keep q.7 <i>Window handle dry keep q.7</i>	04	31,50

HELSINKI
art. 1720



GOTEBORG
art. 1725



OKKAYDO
art. 1735



Prezzi in € - Price in €

ART.	DESCRIZIONE	CONF. PEZZI	INOX SAT/LUC
HELSINKY			
1720	Coppia maniglia c/rosetta Ø52 a pressione e bocchetta foro chiave <i>Handle on rose Ø52 at pressure and escutcheon key hole</i>	01	33,00
1722	Martellina dry keep q.7 <i>Window handle dry keep q.7</i>	04	18,90
GOTEBORG			
1725	Coppia maniglia c/rosetta Ø52 a pressione e bocchetta foro chiave <i>Handle on rose Ø52 at pressure and escutcheon key hole</i>	01	33,00
1727	Martellina dry keep q.7 <i>Window handle dry keep q.7</i>	04	18,90
OKKAYDO			
1735	Coppia maniglia c/rosetta Ø52 a pressione e bocchetta foro chiave <i>Handle on rose Ø52 at pressure and escutcheon key hole</i>	01	61,00
1737	Martellina dry keep q.7 <i>Window handle dry keep q.7</i>	04	30,00

art. 710

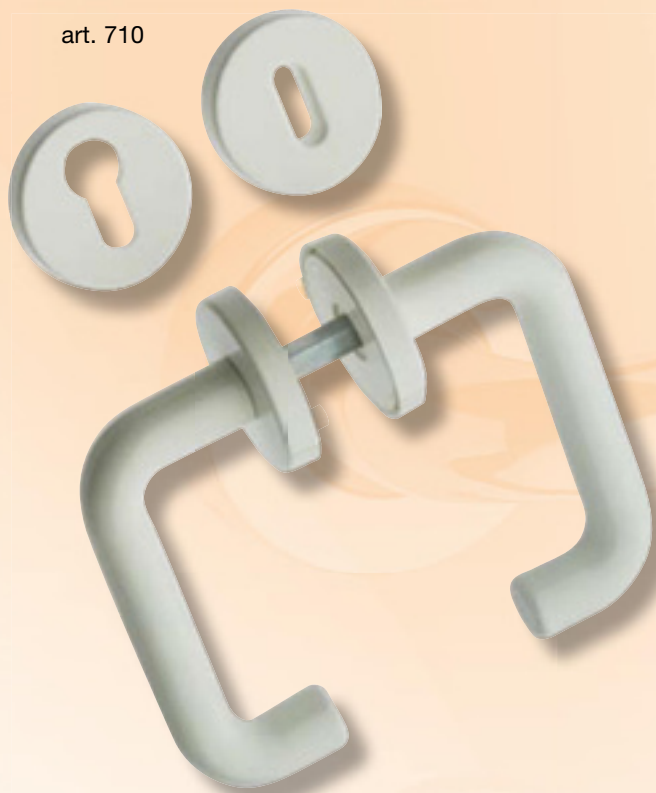

art. 715

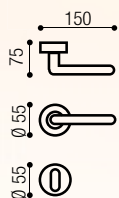

Prezzi in € - Price in €

ART.	DESCRIZIONE	CONF. PEZZI	PVC BIANCO	PVC NERO
710	Set completo maniglia curva c/rosetta Ø50 a pressione e bocchetta foro chiave patent e yale <i>Handles on rose Ø50 at pressure and escutcheon key hole</i>	06	9,80	9,80
713	Martellina dry keep curva q.7 c/rosetta mm 31x61 <i>Dry keep with oval rose mm 31x61</i>	10	8,50	8,50
715	Set completo maniglia diritta c/rosetta Ø50 a pressione e bocchetta foro chiave patent e Yale <i>Handles on rose Ø50 at pressure and escutcheon key hole</i>	06	9,80	9,80
718	Martellina dry keep diritta q.7 c/rosetts mm 31x61 <i>Dry keep with oval rose mm 31x61</i>	10	8,50	8,50



art. 2520

art. 2521



art. 2522



art. 2523

art. 2524



art. 2525



art. 2526

art. 2527



art. 2530

Prezzi in € - Price in €

ART.	DESCRIZIONE	CONF. PEZZI	MISURE MM	OLV	OBG	OCS	Z/OTT	Z/BG	Z/CS
2520	Mostrina coprivite foro Ø46 e Ø50 mm per defender <i>Escutcheon Ø46 and Ø50 mm for defender</i>	24	62x82 H.7	5,40	5,80	5,80			
2521	Cover per defender Ø46 e Ø50 mm <i>Cover for defender Ø46 and Ø50 mm</i>	24	Ø 46	4,20	4,40	4,40			
		24	Ø 50	4,20	4,40	4,40			
2522	Mostrina coprivite foro doppia mappa <i>Escutcheon screw cover double bit key</i>	24	62x82	5,40	5,80	5,80			
2523	Mostrina coprivite foro Yale <i>Escutcheon screw cover Yale key hole</i>	24	62x82	5,40	5,80	5,80			
2524	Mostrina coprivite c/foro mm 10,6 per nottolino a farfalla con codolo Ø8 mm <i>Escutcheon screw cover with hole for cylinder knob</i>	24	62x82	5,40	5,80	5,80			
2525	Mostrina coprivite c/foro Ø22 e sottoplastica c/foro Ø16 per fissaggio maniglia <i>Escutcheon screw cover with hole Ø22 and plastic support with hole Ø16</i>	24	62x82	5,40	5,80	5,80			
2526	Nottolino a farfalla per cilindro yale con codolo Ø8 mm <i>Cylinder knob Ø8 mm</i>	24	37x35				6,50	6,50	6,50
2527	Limitatore di apertura a farfalla quadro mm 8 c/rosetta coprivite Ø50 <i>Safety knob with e escutcheon screw cover Ø50 mm</i>	12	Ø50				12,80	13,90	16,90
2530	Set porta blindata con pomolo Marte Ø65 + ½ maniglia Demetra s/molla e ferro niplax mm 8x100	01		33,50	34,50	36,00			

note



A background image of a hand holding a pen, with horizontal lines overlaid for writing.

morettini®

cerniere
hinges



art. 35



art. 36

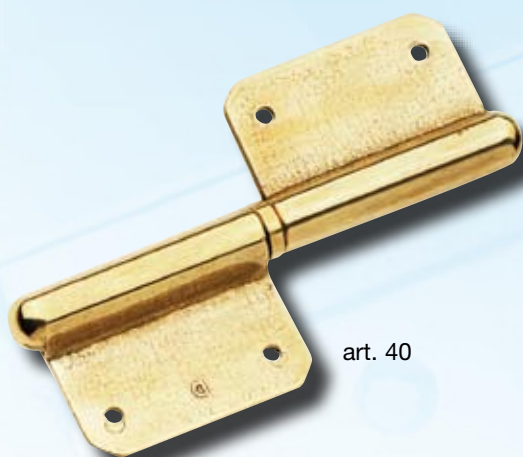

art. 40



art. 43

Prezzi in € - Price in €

ART.	DESCRIZIONE	CONF. PEZZI	MISURE MM	OL	OBR	OCR	OCS	B/INV	OLV
35	Cerniera paumelles dx/sx <i>Paumelles t-hinges right and left</i>	24	80x50	8,13	8,85	11,45	12,60	13,05	13,05
		12	100x55	8,45	9,35	12,10	13,40	13,80	13,80
		12	100x60	8,85	9,75	12,50	14,10	14,40	14,40
		12	120x60	9,25	10,14	12,90	14,50	15,10	15,10
		12	120x75	9,60	10,55	13,35	14,95	15,45	15,45
		12	140x70	10,15	11,35	15,00	15,65	16,15	16,15
		12	140x80	10,75	11,95	15,60	16,25	16,75	16,75
36	Cerniera paumelles bordi tondi dx/sx <i>Paumelles round-edge hinges right and left</i>	12	100x60	9,05	9,95	12,60	14,30	14,60	14,60
		12	120x60	9,65	10,55	13,30	14,90	15,50	15,50
		12	120x70	10,05	11,05	14,20	15,50	16,00	16,00
		12	140x70	10,55	11,75	15,40	16,05	16,55	16,55
		12	140x80	11,15	12,35	16,00	16,55	17,15	17,15
40	Cerniera Bietta dx/sx <i>Bietta t-hinges right and left</i>	12	100	9,80	10,80	13,70	14,85	15,40	15,40
		12	120	10,15	11,20	14,47	15,47	16,00	16,00
		12	140	12,00	13,05	17,05	18,15	18,65	18,65
43	Cerniera maschietto alla Romana dx/sx <i>T-hinges right and left</i>	08	190x100	15,15	16,85	22,10	23,10	22,45	22,45
		06	190x120	18,05	19,95	24,75	26,35	25,45	25,45



art. 44



art. 45



art. 47

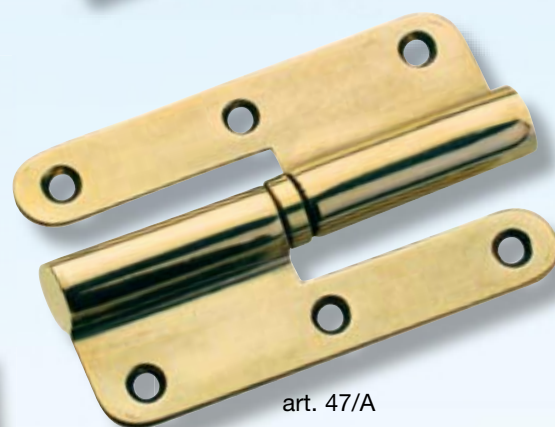

art. 47/A



art. 48

Prezzi in € - Price in €

ART.	DESCRIZIONE	CONF. PEZZI	MISURE MM	OL	OBR	OCR	OCS	B/INV	OLV
44	Cerniera ascensore dx/sx <i>Hinges for lift/elevator right and left</i>	12	65x80	9,45	10,55	13,20	14,50	15,05	15,05
45	Cerniera a libro bordi tondi dx/sx <i>Paumelles round -edge hinges right and left</i>	12	100x65	9,65	10,75	13,15	14,60	15,25	15,25
		12	120x70	10,45	11,75	15,50	16,85	17,30	17,30
		12	140x75	13,95	15,25	19,61	21,15	21,60	21,60
		12	160x80	14,65	15,85	20,65	22,25	22,65	22,65
47	Cerniera a libro con bordi tondi e finale bombato dx/sx <i>Libro round-edge hinges right and left</i>	12	100x65	10,40	11,50	14,15	15,45	16,00	16,00
47/A	Cerniera a libro con bordi tondi e finale piatto dx/sx <i>Libro round-edge hinges right and left</i>	12	100x65	10,40	11,50	14,15	15,45	16,00	16,00
48	Cerniera Zancata dx/sx <i>Clamp hinge right and left</i> Per quantità disponibile la misura da mm 140x70	12	100x65	14,05	15,35	18,30	19,65	20,15	20,15
		08	120x65	14,75	16,05	19,43	20,65	21,15	21,15



art. 50

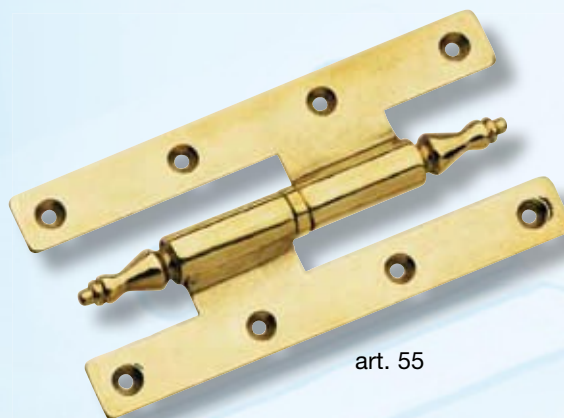

art. 55

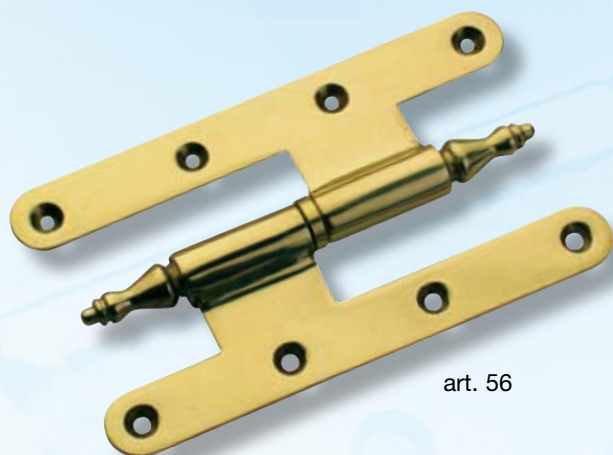

art. 56



art. 57

Prezzi in € - Price in €

ART.	DESCRIZIONE	CONF. PEZZI	MISURE MM	OL	OBR	OCR	OCS	B/INV	OLV	FUMÈ
50	Cerniera in Grossezza dx/sx <i>Key-hinges right and left</i>	12	100	8,80	9,85	11,95	13,30	13,85	13,85	
		12	120	9,85	10,90	13,30	14,75	15,25	15,25	
		12	140	11,70	12,75	15,40	16,70	17,25	17,25	
55	Cerniera Paumelles con capitelli dx/sx <i>Paumelles t-hinges with capitals right and left</i> ocr/ocs solo a richiesta	12	100x55	9,00	10,03	12,65	13,95	14,45	14,45	
		12	100x60	9,25	10,30	13,15	14,50	15,00	15,00	
		12	120x60	9,90	10,95	13,75	15,00	15,55	15,55	
		12	120x75	10,25	11,50	14,25	15,55	16,05	16,05	
		12	140x70	10,95	12,05	14,80	16,10	16,65	16,65	
		12	140x80	11,50	12,60	15,35	16,65	17,20	17,20	
56	Cerniera Paumelles con bordi tondi e capitelli dx/sx <i>Paumelles t-hinges with round-edge and capitals right and left</i>	12	100x60	9,65	10,70	13,55	14,90	15,40	15,40	
		12	120x70	10,85	11,85	15,00	16,30	16,80	16,80	
		12	140x70	11,35	12,45	15,20	16,50	17,05	17,05	
		12	140x80	11,90	13,00	15,75	17,05	17,60	17,60	
57	Cerniera ricamata con capitelli dx/sx <i>Embroidered hinges with capitals right and left</i>	12	120x75	11,10		14,95	16,25	16,75	16,75	13,95



art. 60



art. 65



art. 66



art. 70

Prezzi in € - Price in €

ART.	DESCRIZIONE	CONF. PEZZI	MISURE MM	OL	OBR	OCR	OCS	B/INV	OLV
60	Cerniera Bietta c/piram. dx / sx <i>Thick hinge "Bietta" with capitals right and left</i>	12	100	11,35	12,40	15,15	16,45	16,95	16,95
		12	120	12,55	13,55	15,80	17,10	17,65	17,65
65	Cerniera a libro con capitelli dx/sx <i>Book-shaped hinge with capital right and left</i> Per quantità, sono disponibili anche nella misura da mm 160x80	12	100x65	10,40	11,70	14,25	15,55	16,10	16,10
		12	120x70	11,10	12,40	16,05	17,35	17,95	17,95
66	Cerniera a libro con capitelli e bordi tondi dx/sx <i>Libro round-edge hinges with capitals right and left</i>	12	100x65	10,80	12,10	14,65	16,05	16,60	16,60
70	Cerniera Grossezza con capitelli dx/sx <i>Key-hinges with capitals right and left</i>	12	100	9,65	10,85	13,90	15,20	15,75	15,75
		12	120	10,30	11,50	14,85	16,20	16,75	16,75
		12	140	12,00	13,30	16,45	17,85	18,35	18,35

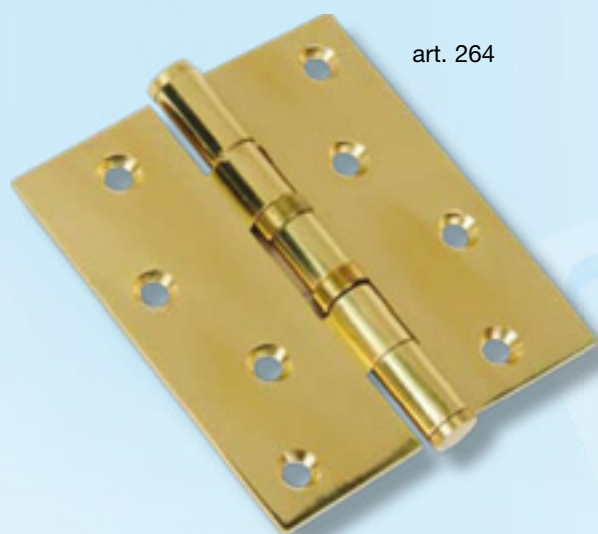

art. 264



art. 263F

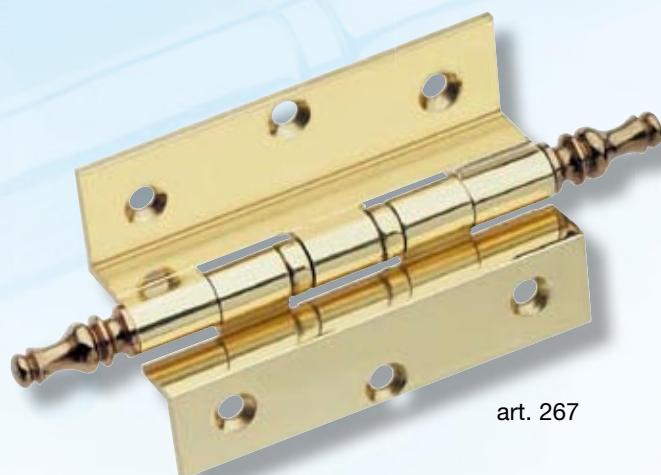

art. 267

Prezzi in € - Price in €

ART.	DESCRIZIONE	CONF. PEZZI	MISURE POLLICI	MISURE MM	OLV	OBV	OCR	OCS
264	Cerniera d'importazione con cuscinetti, canotto Ø12 mm completa di viti, terminale "C" <i>Hinge with bearings terminal "C" choise-sleeve Ø12 mm complete with screws</i>	04	3x2½	76x63	8,16		9,80	
		04	3x3	76x76	9,60		11,40	
		04	3½x3	89x76	12,20		13,85	
		04	4x3	102x76	13,70		15,30	
		04	4x3½	102x89	14,65		16,30	
263/F	Cerniera in ferro con cuscinetti e terminale "C", complete di viti <i>Hinge in iron with bearings terminals "C" complete with screws</i>	04	3x2½	76x63	4,20	4,75	5,05	5,15
		04	3x3	76x76	4,35	5,25	5,55	5,70
		04	3½x3	89x76	4,95	5,50	5,70	6,30
		04	3½x3½	89x89	5,50	5,98		
		04	4x3	102x76	6,20	6,58	6,85	7,15
		04	4x3½	102x89	6,28	7,15	7,70	8,00
267	Cerniera zancata con cuscinetti e terminali A - B - C - D a scelta, con canotto Ø12,5 mm complete di viti <i>Clamped hinges with bearings terminals A - B - C - D to choise, sleeve Ø12,5 mm complete with screws</i>	04	3	76	28,98	28,98	34,75	34,75
		04	3½	89	31,88	31,88	37,68	37,68
		04	4	102	35,50	35,50	41,30	41,30
		04	5	126	39,12	39,12	45,64	45,64

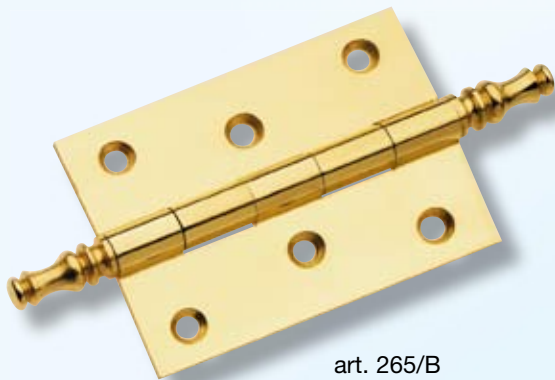

art. 265/B

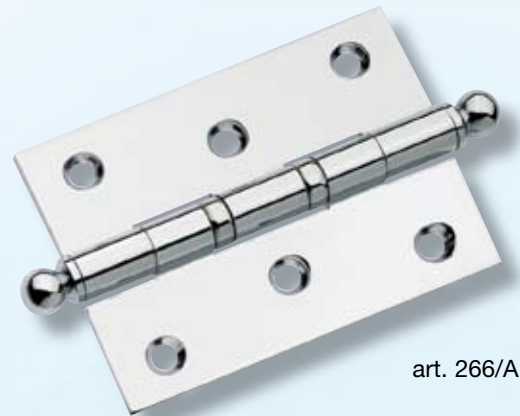

art. 266/A



art. 266/B



art. 266/C

Prezzi in € - Price in €

ART.	DESCRIZIONE	CONF. PEZZI	MISURE POLLICI	MISURE MM	OLV	OBV	OCR	OCS
265	Cerniera senza cuscinetti, terminali A - B - C - D a scelta, con canotto Ø12,5 mm complete di viti <i>Hinge without bearings terminals A - B - C - D to choose-sleeve Ø12,5 mm complete with screws</i>	04	3x3	76x76	18,85	18,85	23,90	23,90
		04	3½x3	89x76	22,89	22,89	28,70	28,70
		04	3½x3½	89x89	24,34	24,34	30,15	30,15
		04	4x3	102x76	25,50	25,50	31,30	31,30
		04	4x3½	102x89	27,50	27,50	33,30	33,30
		03	4x4	102x102	30,40	30,40	36,22	36,22
		03	4½x4	115x102	34,00	34,00	39,85	39,85
		03	4½x4½	115x115	35,50	35,50	41,30	41,30
		03	5x3½	126x89	38,40	38,40	44,20	44,20
		03	5x4	126x102	39,85	39,85	45,60	45,60
		266	Cerniera con cuscinetti terminali A - B - C - D a scelta, con canotto Ø12,5 mm complete di viti. <i>Hinge with bearings terminals A - B - C - D to choose-sleeve Ø12,5 mm complete with screws.</i>	04	3x3	76x76	20,28	20,28
04	3½x3			89x76	24,35	24,35	30,15	30,15
04	3½x3½			89x89	25,80	25,80	31,60	31,60
04	4x3			102x76	26,95	26,95	32,75	32,75
04	4x3½			102x89	28,95	28,95	34,78	34,78
03	4x4			102x102	31,88	31,88	37,68	37,68
03	4½x4			115x102	35,50	35,50	41,30	41,30
03	4½x4½			115x115	36,95	36,95	42,75	42,75
03	5x3½			126x89	39,85	39,85	45,65	45,65
03	5x4			126x102	41,30	41,30	47,10	47,10
03	6x3½			152x89	52,16	52,16	60,14	60,14
03	6x4			152x102	53,60	53,60	61,58	61,58
03	6x4½			152x115	56,50	56,50	64,48	64,48

note

A large, semi-transparent image of a sliding door roller assembly, showing a cylindrical roller with a curved top and a mounting bracket with two screws, set against a teal background.

kit porte scorrevoli
slidings doors kit



Prezzi in € - Price in €

ART.	DESCRIZIONE	CONF. PEZZI	MISURE MM	OLV	OBG	OCR	OCS
860	Kit nicchia ad incasso tonda con nottolino e ditale di trascinamento <i>Sliding door kit without lock</i>	06	Ø57 h 12 Ø48 incasso	20,50	21,50	22,50	22,50
861	Kit nicchia ad incasso to tonda con foro chiave e ditale di trascinamento <i>Sliding door kit without lock</i>	06	Ø57 h 12 Ø48 incasso	13,00	14,00	14,50	14,50
862	Kit nicchia ad incasso tonda cieca e ditale di trascinamento <i>Sliding door kit without lock</i>	06	Ø57 h 12 Ø48 incasso	13,00	14,00	14,50	14,50
863	Nicchia ad incasso tonda con foro chiave <i>Sliding door handle with key hole</i>	12	Ø57 h 12 Ø48 incasso	4,95	5,35	5,55	5,55
864	Nicchia ad incasso tonda cieca <i>Sliding door handle without key hole</i>	12	Ø57 h 12 Ø48 incasso	4,95	5,35	5,55	5,55



art. 865



art. 865/A

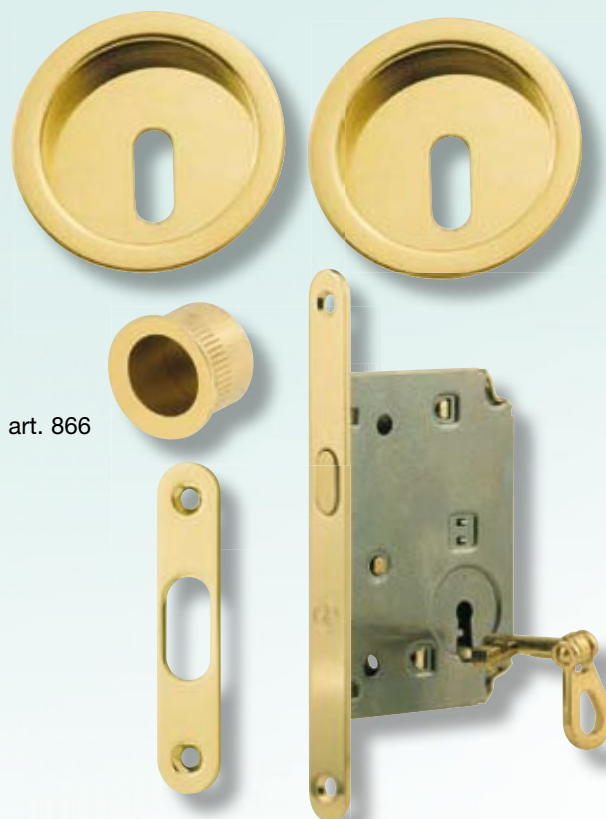

art. 866

Prezzi in € - Price in €

ART.	DESCRIZIONE	CONF. PEZZI	MISURE MM	OLV	OBG	OCR	OCS
865	Kit nicchia ad incasso tonda con nottolino, ditale di trascinamento e serratura <i>Sliding door kit with lock</i>	01	Ø57 h 12 Ø48 incasso	27,00	28,50	30,00	29,00
865/A	Kit nicchia ad incasso tonda con due nottolini, ditale di trascinamento e serratura <i>Sliding door kit with lock</i>	01	Ø57 h 12 Ø48 incasso	32,00	33,50	35,00	34,00
866	Kit nicchia ad incasso tonda con foro chiave, ditale di trascinamento e serratura <i>Sliding door kit with key lock</i>	01	Ø57 h 12 Ø48 incasso	21,00	22,50	24,50	22,50

art. 870



art. 871



art. 872



art. 873



art. 874



Prezzi in € - Price in €

ART.	DESCRIZIONE	CONF. PEZZI	MISURE MM	OLV	OBG	OCR	OCS	B/INV	B/ANT
870	Kit nicchia ad incasso tonda con nottolino q.6 e ditale di trascinamento <i>Sliding door kit without lock</i>	01	Ø57 h 12 Ø48 incasso	22,00	23,00	24,00	23,00	23,00	24,00
871	Kit nicchia ad incasso tonda con foro chiave e ditale di trascinamento <i>Sliding door kit with key hole</i>	06	Ø57 h 12 Ø48 incasso	14,50	15,50	17,00	16,00	16,00	17,00
872	Kit nicchia ad incasso tonda cieca e ditale di trascinamento <i>Sliding door kit without lock</i>	06	Ø57 h 12 Ø48 incasso	14,50	15,50	17,00	16,00	16,00	17,00
873	Nicchia ad incasso tonda con foro chiave <i>Sliding door handle with key hole</i>	24	Ø57 h 12 Ø48 incasso	5,70	6,10	7,10	6,10	6,10	7,10
874	Nicchia ad incasso tonda cieca <i>Sliding door handle without key hole</i>	24	Ø57 h 12 Ø48 incasso	5,70	6,10	7,10	6,10	6,10	7,10



art. 875

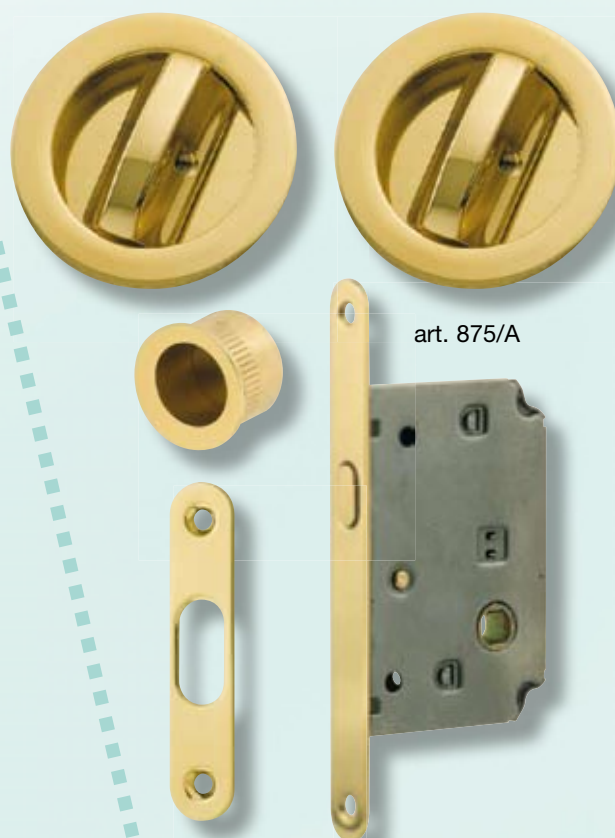

art. 875/A

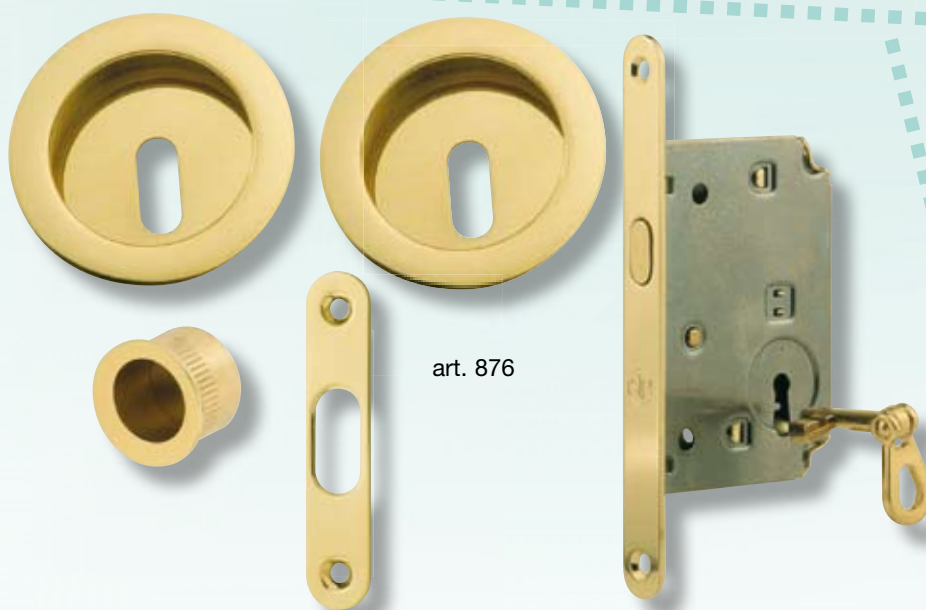

art. 876



art. 877

Prezzi in € - Price in €

ART.	DESCRIZIONE	CONF. PEZZI	MISURE MM	OLV	OBG	OCR	OCS	B/INV	B/ANT
875	Kit nicchia ad incasso tonda con nottolino q.6 e ditale di trascinamento e serratura <i>Sliding door kit with lock</i>	01	Ø57 h 12 Ø48 incasso	29,00	31,00	32,00	31,00	31,00	32,00
875/A	Kit nicchia ad incasso tonda con nottolino q.6 e ditale di trascinamento e serratura <i>Sliding door kit with lock</i>	01	Ø57 h 12 Ø48 incasso	34,00	35,50	36,50	35,50	35,50	36,50
876	Kit nicchia ad incasso tonda con foro chiave e ditale di trascinamento e serratura <i>Sliding door kit with key lock</i>	01	Ø57 h 12 Ø48 incasso	23,00	24,00	26,00	24,00	24,00	26,00
877	Nicchia ad incasso mezzaluna tonda <i>Sliding door handle without key hole</i>	24	Ø57 h 12 Ø48 incasso	8,15	8,90	8,90	8,90		

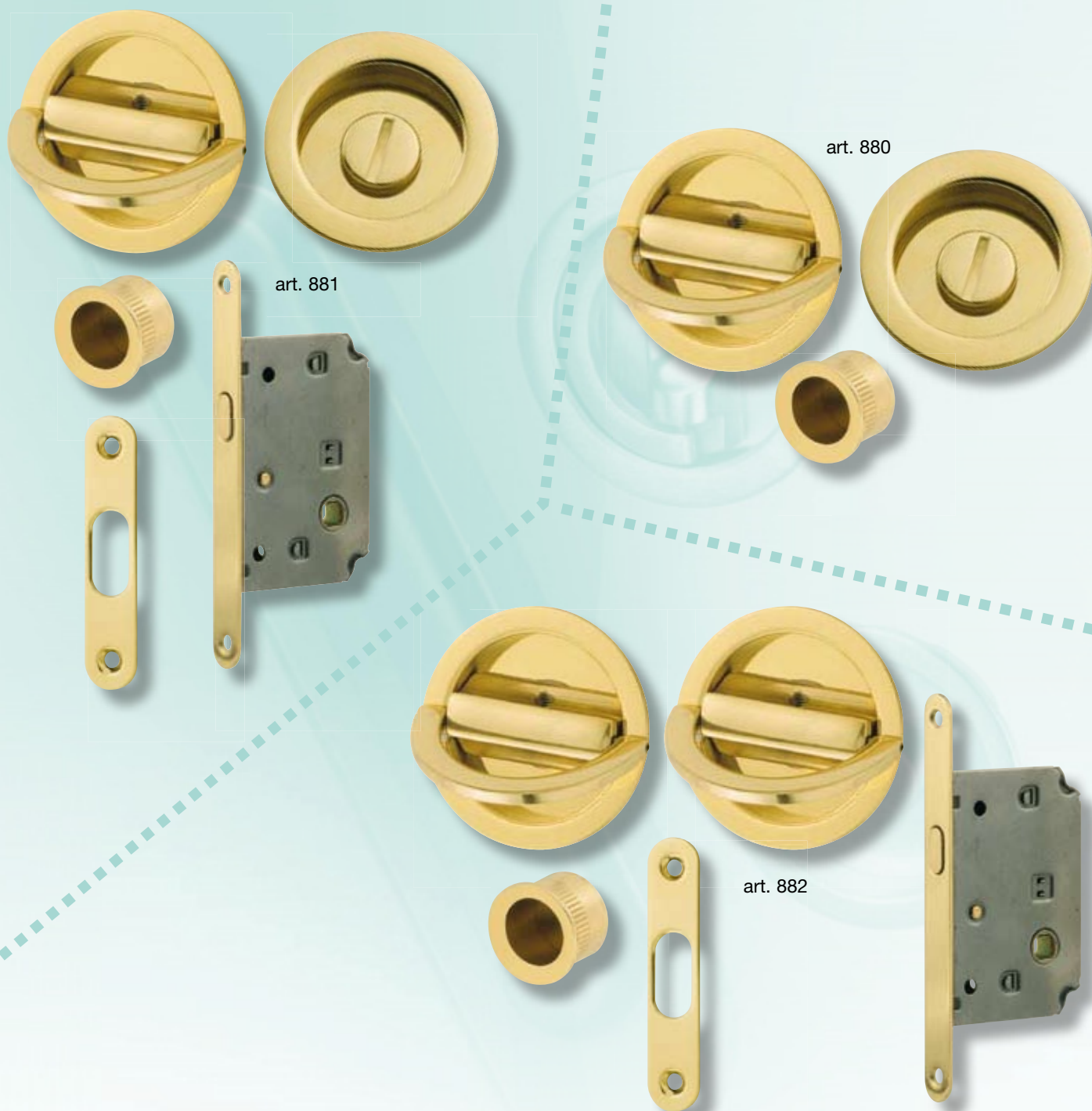

Prezzi in € - Price in €

ART.	DESCRIZIONE	CONF. PEZZI	MISURE MM	OLV	OBG	OCR	OCS
880	Kit nicchia ad incasso tonda nottolino c/pendente e ditale di trascinamento <i>Sliding door kit without lock</i>	01	Ø57 h 12 Ø48 incasso	31,00	32,00	35,00	33,00
881	Kit nicchia ad incasso tonda, nottolino c/pendente e serratura e ditale di trascinamento <i>Sliding door kit with lock</i>	01	Ø57 h 12 Ø48 incasso	39,00	40,00	44,00	42,00
882	Kit nicchia ad incasso tonda, due nottolini c/pendente, serratura e ditale di trascinamento <i>Sliding door kit with lock</i>	01	Ø57 h 12 Ø48 incasso	51,00	52,00	56,00	54,00



art. 885Q

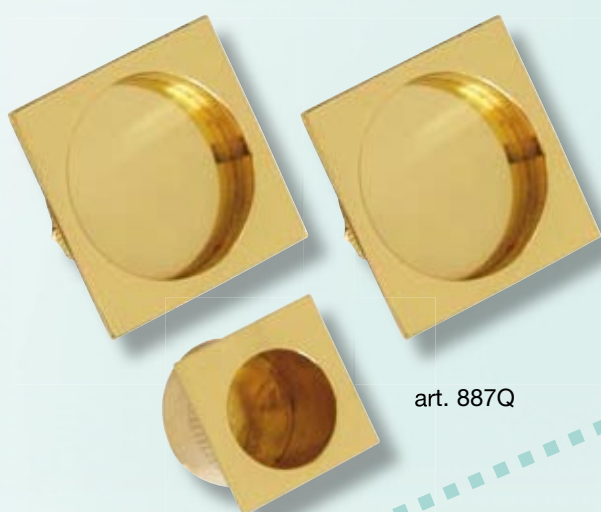

art. 887Q

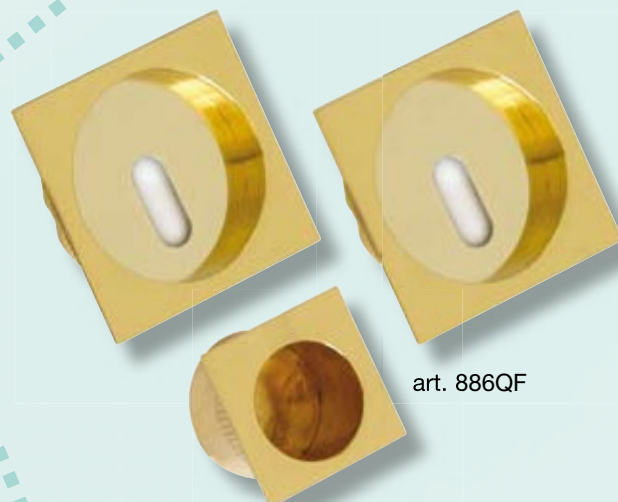

art. 886QF

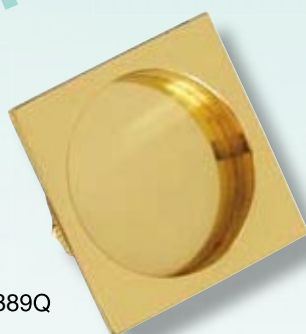

art. 889Q



art. 888QF



art. 890Q

Prezzi in € - Price in €

ART.	DESCRIZIONE	CONF. PEZZI	MISURE MM	OLV	OCR	OCS
885Q	Kit nicchia ad incasso quadra con nottolino e ditale di trascinamento <i>Sliding door kit without lock</i>	01	52x52 h 12 Ø48 incasso	26,00	26,00	26,00
886QF	Kit nicchia ad incasso quadra con foro chiave e ditale di trascinamento <i>Sliding door kit with key hole, without lock</i>	06	52x52 h 12 Ø48 incasso	16,00	16,00	16,00
887Q	Kit nicchia ad incasso quadra cieca e ditale di trascinamento <i>Sliding door kit without lock</i>	06	52x52 h 12 Ø48 incasso	16,00	16,00	16,00
888QF	Kit Nicchia ad incasso quadra con foro chiave <i>Sliding door handle with key hole</i>	12	52x52 h 12 Ø48 incasso	7,00	7,00	7,00
889Q	Nicchia ad incasso mezzaluna quadra <i>Sliding door handle without key hole</i>	12	52x52 h 12 Ø48 incasso	8,50	8,50	8,50
890Q	Nicchia ad incasso mezzaluna quadra <i>Sliding door handle without key hole</i>	12	52x52 h 12 Ø48 incasso	8,50	8,50	8,50



Prezzi in € - Price in €

ART.	DESCRIZIONE	CONF. PEZZI	MISURE MM	OLV	OCR	OCS
891Q	Kit nicchia ad incasso to quadra con nottolino e ditale e serratura <i>Sliding door kit with lock</i>	01	52x52 h 12 Ø48 incasso	33,00	33,00	33,00
892Q	Kit nicchia ad incasso quadra con doppio nottolino ditale di trascinamento e serratura <i>Sliding door kit with lock</i>	01	52x52 h 12 Ø48 incasso	38,50	38,50	38,50
893QF	Kit nicchia ad incasso quadra con foro chiave e ditale e serratura <i>Sliding door kit with key lock</i>	01	Ø57 h 12 Ø48 incasso	26,00	26,00	26,00



art. K270



art. K271



art. 480



art. 480F



art. 536PL

Prezzi in € - Price in €

ART.	DESCRIZIONE	CONF. PEZZI	MISURE MM	OLV	OBG	OCR	OCS	B/INV	B/ANT
K270	Kit nicchia ad incasso ovale coprivite c/nottolino basso, serratura e ditale <i>Oval sliding door kit with lock</i>	02	125x39 incasso 85x26	31,50	31,50		31,50		
K271	Kit nicchia ad incasso ovale coprivite con foro chiave, serratura e ditale di trascinamento <i>Oval sliding door kit with key hole and lock</i>	02	125x39 incasso 85x26	28,00	28,00		28,00		
480	Nicchia incasso ovale coprivite senza foro chiave con sottoplastica <i>Flush "screw cover" plate without hole</i>	24	125x39 incasso 85x26	7,70	8,30		9,40	9,40	9,40
480F	Nicchia incasso ovale coprivite senza foro chiave con sottoplastica <i>Flush "screw cover" plate without hole</i>	24	125x39 incasso 85x26	7,70	8,30		9,40	9,40	9,40
536PL	Nicchia di trascinamento in resina con frontale in ottone (Ø25 parte che va incassata) <i>Round handle for sliding door</i>	50	29x20 h incasso Ø25	3,90	3,90	3,90	4,00	3,90	



art. K300R



art. K301R



art. 480R



art. 480RF



art. 484Q

Prezzi in € - Price in €

ART.	DESCRIZIONE	CONF. PEZZI	MISURE MM	OLV	OBG	OCR	OCS
K300R	Kit Kit nicchia ad incasso rettango. copriv. c/nottolino basso, serratura e ditale di trascinamento <i>Rett. sliding door kit with lock</i>	02	125x39 incasso 85x26	31,50	31,50		31,50
K301R	Kit nicchia ad incasso rettangolare copriv. c/foro chiave, serratura e ditale di trascinamento <i>Rett. sliding door kit with key hole and lock.</i>	02	125x39 incasso 85x26	28,00	28,00		28,00
480R	Nicchia incasso rettangolare coprivite senza foro chiave con sottoplastica <i>Flush "screw cover" plate without hole</i>	24	125x39 incasso 85x26	7,70	8,30		9,40
480RF	Nicchia incasso rettangolare coprivite con foro chiave e sottoplastica <i>Flush "screw cover" plate with hole</i>	24	125x39 incasso 85x26	7,70	8,30		9,40
484Q	Kit nicchia ditale di trascinamento quadro (Ø25 parte che va incassata) <i>Square handle for sliding door</i>	24	27x27x20 h incasso Ø25	4,20	4,20	4,20	4,20

art. 480



art. 480R



art. 480RF



art. 480F



art. 480B

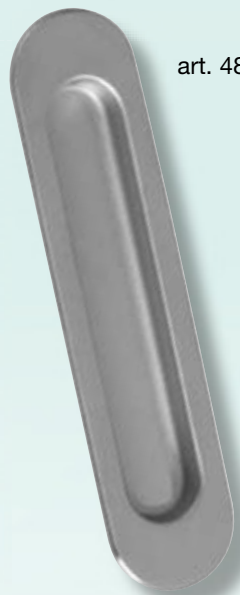

art. 480BF

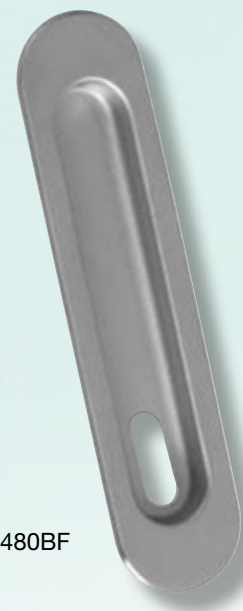

Prezzi in € - Price in €

ART.	DESCRIZIONE	CONF. PEZZI	MISURE MM	OLV	OBG	OCS	B/INV B/ANT	OSV
480	Nicchia incasso ovale coprivite senza foro chiave, con sottoplastica <i>Flush "screw cover" plate without hole</i>	24	125x39 incasso 85x26	7,70	8,30	9,40	9,40	8,30
480F	Nicchia incasso ovale coprivite con foro chiave e sottoplastica <i>Flush "screw cover" plate with key hole</i>	24	125x39 incasso 85x26	7,70	8,30	9,40	9,40	8,30
480R	Nicchia incasso rettangolare coprivite senza foro chiave con sottoplastica <i>Flush "screw cover" plate without hole</i>	24	125x39 incasso 85x26	7,70	8,30	9,40		
480RF	Nicchia incasso rettangolare coprivite con foro chiave e sottoplastica <i>Flush "screw cover" plate with key hole</i>	24	125x39 incasso 85x26	7,70	8,30	9,40		
480B	Kit nicchia incasso ovale coprivite senza foro chiave con sottoplastica <i>Flush "screw cover" plate without hole</i>	12	152x36 incasso 120x26	15,45	16,70	18,90		
480BF	Nicchia incasso ovale coprivite con foro chiave e sottoplastica <i>Flush "screw cover" plate with key hole</i>	12	152x36 incasso 120x26	15,45	16,70	18,90		



art. 481



art. 481F



art. 489



art. 489F



art. 900E50



art. 901E50

Prezzi in € - Price in €

ART.	DESCRIZIONE	CONF. PEZZI	MISURE MM	OLV	OBG	OCR	OCS
481	Nicchia incasso ovale con viti in vista senza foro chiave, in ottone massiccio <i>Flush plate without hole</i>	24	125x36 incasso 93x23	9,50	9,95		10,40
481F	Nicchia incasso ovale viti in vista con foro chiave, in ottone massiccio <i>Flush plate with key hole.</i>	24	125x36 incasso 93x23	9,50	9,95		10,40
489	Placca ad incasso lunga senza foro chiave, viti in vista <i>Sliding door handle without key hole</i>	20	250x40 incasso 85x25	14,80	15,20	15,60	15,60
489F	Kit Placca ad incasso lunga con foro chiave, viti in vista <i>Sliding door handle with key hole</i>	20	250x40 incasso 85x25	14,80	15,20	15,60	15,60
900E50	Serratura a gancio q.8 per porte scorr. entrata mm 50 <i>Sliding door lock sq.8</i>	12		10,50	10,50		10,50
901E50	Serratura a gancio c/foro chiave e chiave piegata entrata mm 50 <i>Sliding door lock with key</i>	12		12,00	12,00		12,00



art. 445

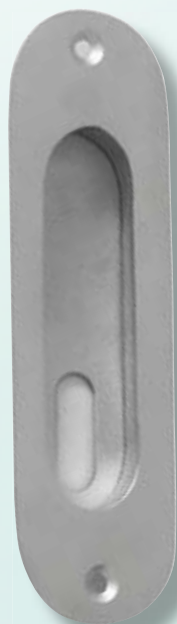

art. 445F

art. 482



art. 484Q

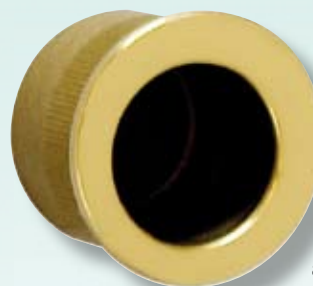

art. 536PL

Prezzi in € - Price in €

ART.	DESCRIZIONE	CONF. PEZZI	MISURE MM	OLV	OBG	OCR	OCS	B/INV B/ANT
445	Nicchia incasso ovale con appiglio, viti in vista senza foro chiave <i>Flush plate without hole</i>	24	120x33 incasso 85x25	7,90	8,70		9,60	
445F	Nicchia incasso ovale con appiglio, viti in vista con foro chiave <i>Flush plate with key hole</i>	24	120x33 incasso 85x25	7,90	8,70		9,60	
482	Nicchia ad incasso tonda in zama <i>Round handle for sliding door</i>	50	Ø40 inc. Ø35	5,10	7,50	5,10	5,10	
		50	Ø45 inc. Ø40	5,55	7,95	5,55	5,55	
484Q	Nicchia incasso quadra ditale di trascinamento (Ø25 parte che va incassata) <i>Square handle for sliding door</i>	24	27x27x20 h incasso Ø25	4,20	4,20	4,20	4,20	
536PL	Ditale di trascinamento in resina con frontale in ottone (Ø25 parte che va incassata) <i>Round handle for sliding door</i>	50	Ø29x20 h incasso Ø25	3,90	3,90	3,90	4,00	3,90



art. 497



art. 497/A



art. 498



art. 499



art. 499/A



art. 500



art. 531



art. SWC652



Prezzi in € - Price in €

ART.	DESCRIZIONE	CONF. PEZZI	MISURE MM	OLV	OBG	OCR	OCS	B/INV B/ANT	INOX SAT
497	Nottolino q.8 su rosetta ad avvitare Ø50 (limitatore di apertura) <i>Door-lact with Ø50 Rose spindle q.8</i>	12	50x42	13,50	14,50	15,50	15,50		
497/A	Kit nottolino WC q.8 c/rosetta Ø50 coprivite ad avvitare <i>Wc set, spindle q.8 with rose Ø50 screw cover</i>	06	rosetta Ø50	21,50	23,50	24,50	24,50		
498	Nottolino WC q.6 senza rosette c/filetto e grano <i>Wc set, spindle q.6 without rose</i>	12		10,00	10,50	10,50	10,50	10,50	
499	Kit nottolino WC q.6 c/rosetta Ø45 coprivite a pressione <i>Wc set, spindle q.6 with rose Ø45</i>	12	rosetta Ø45 h 9	14,50	15,20	15,20	15,20	15,20	
500	Kit nottolino WC q.6 c/rosetta Ø50 coprivite ad avvitare <i>Wc set, spindle q.6 with rose Ø50 screw cover</i>	06	rosetta Ø50	21,50	23,50	24,50	24,50	24,50	
499A	Kit nottolino WC c/rosetta Ø45 copriv. a pressione e finestra libero/occupato <i>Wc set, spindle q.6 with rose Ø45 screw cover</i>	12	rosetta Ø45 h 7	17,80		18,50	18,50		
531	Kit nottolino WC c/rosetta coprivite quadra a pressione e finestra libero/occupato <i>Wc set, with rose 45x45 screw cover</i>	12	rosetta 45x45	18,10		18,80	18,80		
SWC652	Kit nottolino WC q.6/8 c/rosetta Ø52 coprivite a pressione e finestra libero occupato <i>Wc set, spindle q.6/8 with rose Ø52 screw cover</i>	12	rosetta Ø52						18,00



art. 2500



art. 2501



art. 2502



art. 2503



art. 2504

Prezzi in € - Price in €

ART.	DESCRIZIONE	CONF. PEZZI	MISURE MM	OLV	OCR	OCS
2500	Kit nicchia ad incasso tonda con nottolino e ditale di trascinamento <i>Sliding door kit without lock</i>	04	Ø70 h 14 Ø48 incasso	32,50	32,50	32,50
2501	Kit nicchia ad incasso tonda con foro chiave e ditale di trascinamento <i>Sliding door kit without lock</i>	06	Ø70 h 14 Ø48 incasso	23,10	23,10	23,10
2502	Kit nicchia ad incasso tonda cieca e ditale di trascinamento <i>Sliding door kit without lock</i>	06	Ø70 h14 Ø48 incasso	23,10	23,10	23,10
2503	Nicchia ad incasso tonda con foro chiave <i>Sliding door handle with key hole</i>	12	Ø70 h 14 Ø48 incasso	10,75	10,75	10,75
2504	Nicchia ad incasso tonda cieca <i>Sliding door handle without key hole</i>	12	Ø70 h 14 Ø48 incasso	10,75	10,75	10,75

art. 2505



art. 2506

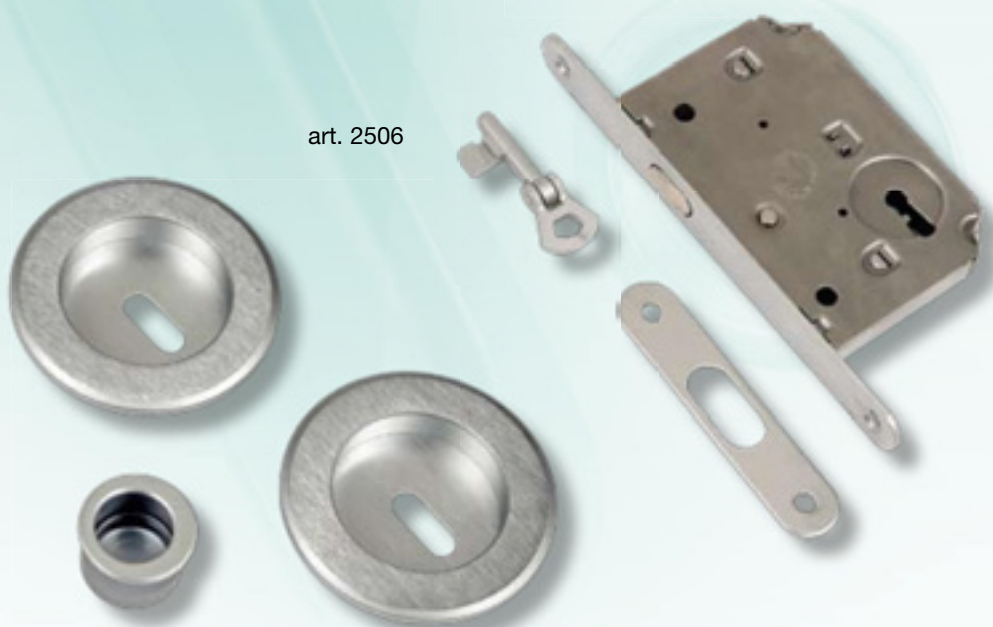

Prezzi in € - Price in €

ART.	DESCRIZIONE	CONF. PEZZI	MISURE MM	OLV	OCR	OCS
2505	Kit nicchia ad incasso tonda con nottolino e ditale di trascinamento e serratura <i>Sliding door kit with lock</i>	02	Ø70 h 14 Ø48 incasso	40,20	40,20	40,20
2506	Kit nicchia ad incasso tonda con foro chiave e ditale di trascinamento e serratura <i>Sliding door kit with lock</i>	02	Ø70 h 14 Ø48 incasso	33,50	33,50	33,50

art. 2510



art. 2511

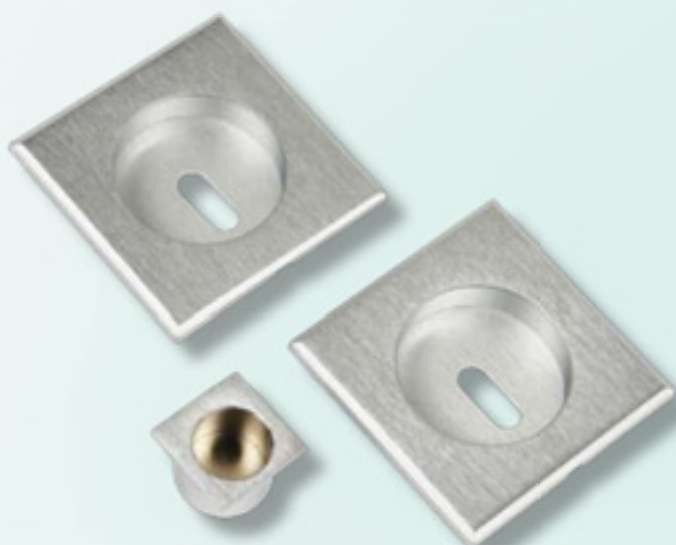

art. 2512

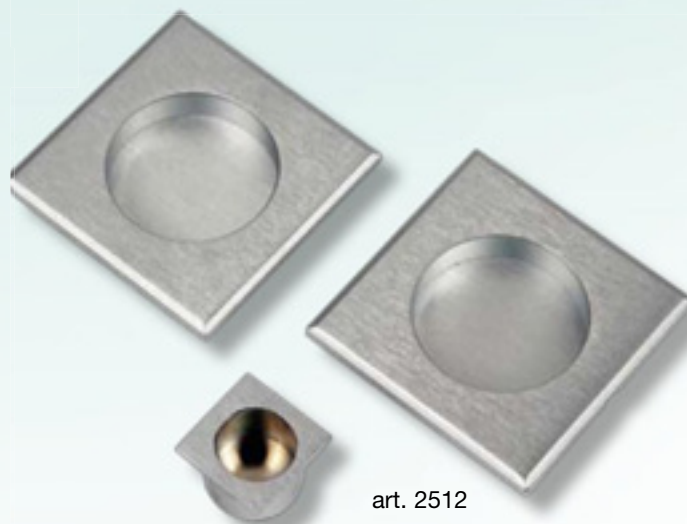

Prezzi in € - Price in €

ART.	DESCRIZIONE	CONF. PEZZI	MISURE MM	OLV	OCR	OCS
2510	Kit nicchia ad incasso quadrato con nottolino e ditale di trascinamento <i>Sliding door kit without lock</i>	04	70x70 h 14 Ø48 incasso	34,00	34,00	34,00
2511	Kit nicchia ad incasso quadrato con foro chiave e ditale di trascinamento <i>Sliding door kit without lock</i>	06	70x70 h 14 Ø48 incasso	24,50	24,50	24,50
2512	Kit nicchia ad incasso quadratocieca e ditale di trascinamento <i>Sliding door kit without lock</i>	06	70x70 h 14 Ø48 incasso	24,50	24,50	24,50

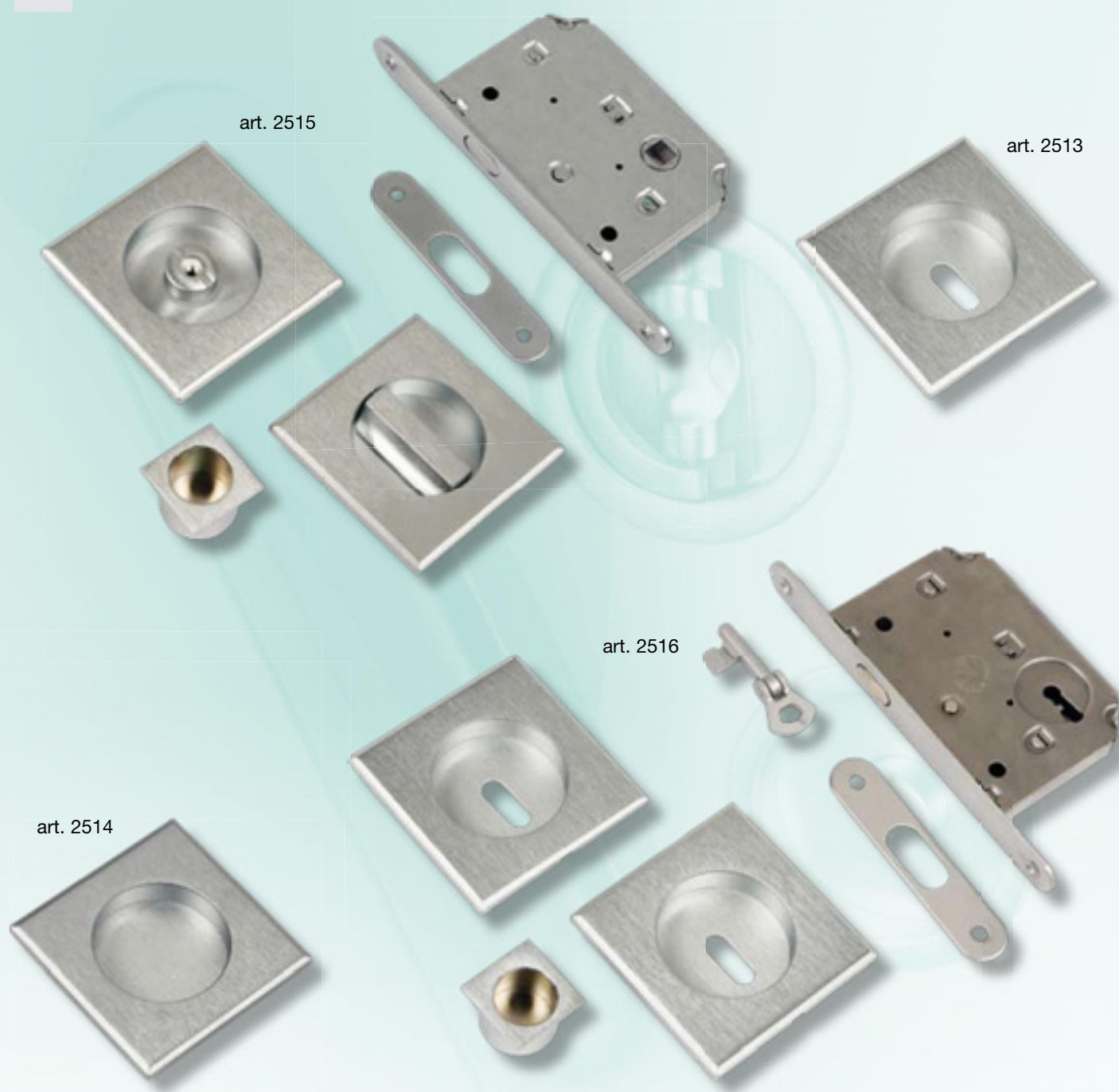

Prezzi in € - Price in €

ART.	DESCRIZIONE	CONF. PEZZI	MISURE MM	OLV	OCR	OCS
2513	Nicchia ad incasso quadrato con foro chiave <i>Sliding door handle with key hole</i>	12	70x70 h 14 Ø48 incasso	10,90	10,90	10,90
2514	Nicchia ad incasso quadra cieca <i>Sliding door handle without key hole</i>	12	70x70 h 14 Ø48 incasso	10,90	10,90	10,90
2515	Kit nicchia ad incasso quadrato con nottolino e ditale di trascinamento e serratura <i>Sliding door kit with lock</i>	02	70x70 h 14 Ø48 incasso	42,00	42,00	42,00
2516	Kit nicchia ad incasso quadrato con foro chiave e ditale di trascinamento e serratura <i>Sliding door kit with lock</i>	02	70x70 h 14 Ø48 incasso	34,00	34,00	34,00

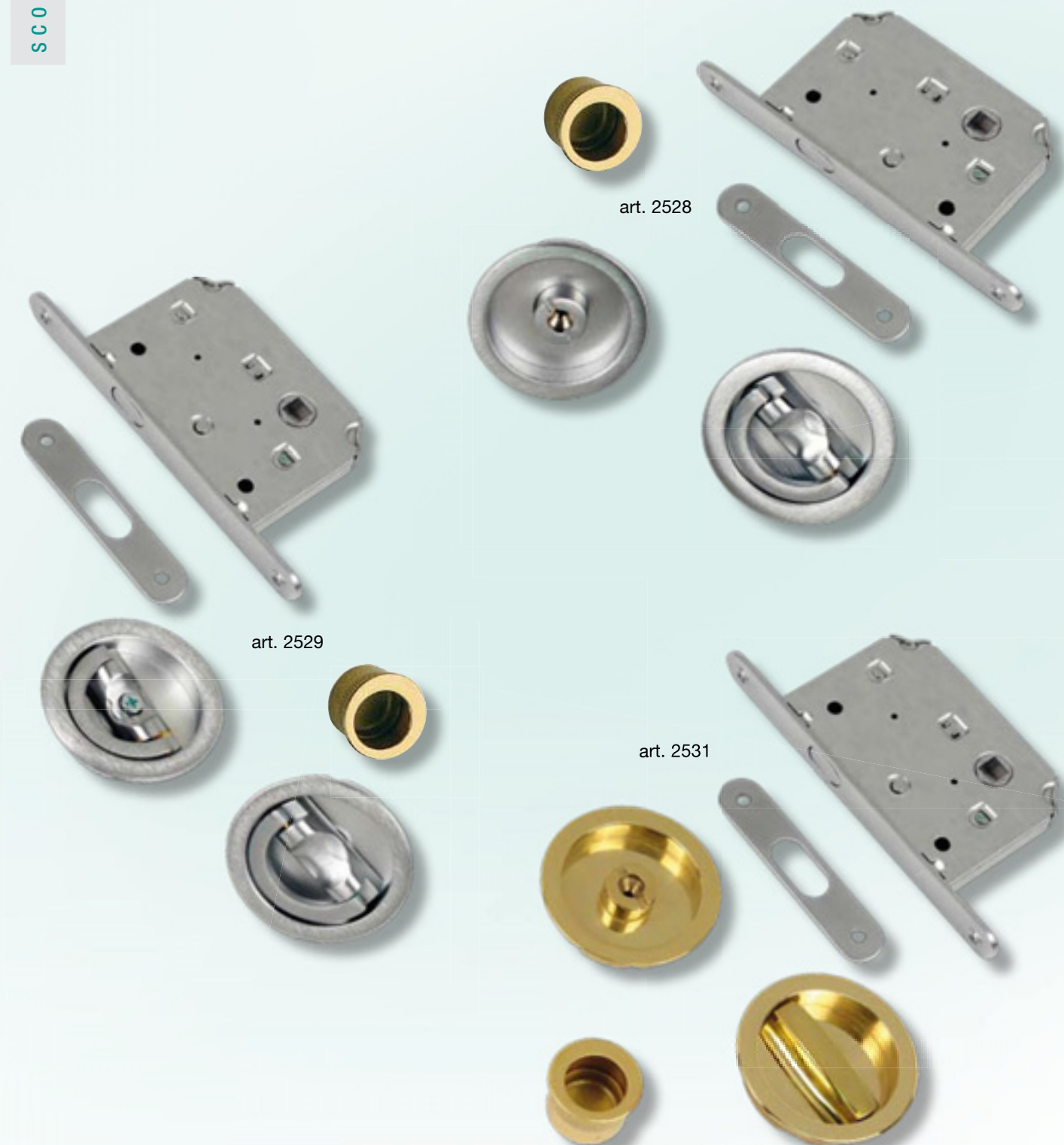

Prezzi in € - Price in €

ART.	DESCRIZIONE	CONF. PEZZI	MISURE MM	OLV	OCS
2528	Kit nicchia ad incasso tonda con pendente nottolino q.8, ditale di trascinamento e serratura <i>Sliding door kit with pendent and lock</i>	01	Ø57 h 12 Ø48 incasso	29,60	29,60
2529	Kit nicchia ad incasso tonda con doppio pendente nottolino q.8, ditale di trascinamento e serratura <i>Sliding door kit with double pendent and lock</i>	01	Ø57 h 12 Ø48 incasso	31,50	31,50
2531	Kit nicchia incasso tonda con nottolino fissaggio a vite serratura e ditale <i>Sliding door kit with key lock</i>	01	Ø57 h 12 Ø48 incasso	27,00	28,50

note



battenti
door knockers



art. 37 A/B/C



art. 38 A/B/C



art. 39 A/B



art. 413

Prezzi in € - Price in €

ART.	DESCRIZIONE	CONF. PEZZI	MISURE MM l h	OLV	FUMÈ	B/INV	BR. YEST	OCS	FE/ANT	PVD
37 C	Battente Barocco con rosetta da mm 80 <i>Baroque type knocker</i>	01	100 120	77,40	77,40	77,40	80,30	87,00		172,00
37 B	Battente Barocco con rosetta da mm 80 <i>Baroque type knocker</i>	01	120 150	89,00	89,00	89,00	92,20	109,00		178,50
37 A	Battente Barocco con rosetta da mm 105 <i>Baroque type knocker</i>	01	140 180	134,00	134,00	134,00	139,80	154,50		267,00
38 C	Battente Anello con rosetta da mm 80 <i>Ring knocker</i>	02	Ø est. 90	61,50	61,50	61,50	61,50	91,20		138,80
38 B		02	Ø est. 110	69,40	69,40	69,40	69,40	93,20		162,50
38 A		02	Ø est. 130	71,40	71,40	71,40	71,40	95,00		172,50
39 B	Battente Leone piccolo <i>Small "Leone" closer</i>	04	90 120	34,00	34,00	34,00	37,00	46,00	49,00	76,90
39 A	Battente Leone grande <i>Large "Leone" closer</i>	03	120 80	43,00	43,00	43,00	43,00	55,40	64,60	129,00
413	Battente Lira con rosetta da mm 80 <i>Lyre knocker</i>	02	90 100	81,30	81,30	81,30	81,30		109,00	



art. 286 A/B



art. 412



art. 414



art. 427



art. 428 A/B

Prezzi in € - Price in €

ART.	DESCRIZIONE	CONF. PEZZI	MISURE MM l h	OLV	FUMÈ	B/INV	BR. YEST	OCS	FE/ANT	PVD
286	B - Battente Europa <i>Europa knocker</i>	02	110 150	61,50	67,70	67,70	67,70			
	A - Battente Europa <i>Europa knocker</i>	01	150 210	91,20	91,20	91,20	93,20			
414	Battente London con rosetta da mm 80 <i>London knocker</i>	01	110 135	93,20	93,20	93,20	93,20	118,90	113,00	
427	C - Battente Garda fissaggio solo con troncone passante <i>Garda knocker</i>	02	120 120	78,80	85,40	85,40				
	B - Battente Garda fissaggio con piastrina filettata <i>Garda knocker</i>	02	100 100	81,30	81,30	81,30	81,30	101,00	113,00	166,50
	A - Battente Garda fissaggio con piastrina filettata <i>Garda knocker</i>	02	120 120	97,10	99,15	99,15	99,15	119,00	119,00	184,40
428	B - Battente Garda fissaggio con piastrina filettata	02	90 110	86,30	86,30	86,30	86,30	109,00		172,50
	A - Battente Garda fissaggio con piastrina filettata	02	110 130	99,10	99,10	99,10	99,10	127,90		187,00
412	Campanello Leone <i>Lion bell</i>	12	75x60	23,60	24,60	24,60		30,75		

art. 1170



art. 1175



art. 1180

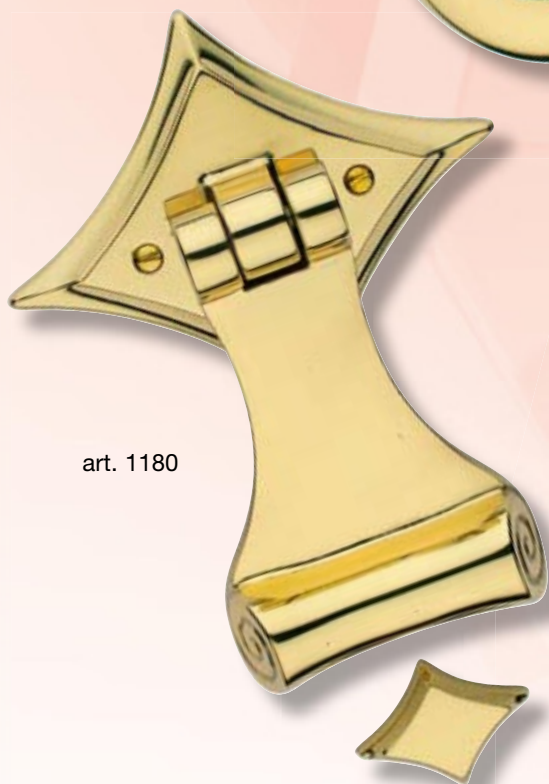

art. 1185



Prezzi in € - Price in €

ART.	DESCRIZIONE	CONF. PEZZI	MISURE MM l h	OLV	FUMÈ	B/INV	OCS	FE/ANT	PVD
1170	Battente Venezia <i>Venezia knocker</i>	01	90 130	79,50	79,50	79,50	103,00	89,00	158,00
1175	Battente Firenze <i>Firenze knocker</i>	01	90 130	77,50	77,50	77,50	95,20		172,50
1180	Battente New York <i>New York knocker</i>	01	130 170	83,50	83,50	83,50		105,00	
1185 B	Battente Inglese <i>English knocker</i>	01	80 150	28,00	28,00	28,00	49,50		72,00
1185 A	Battente Inglese <i>English knocker</i>	01	100 190	37,20	37,20	37,20	55,50		82,00



art. 840

art. 841/A
art. 841/B

art. 842

Prezzi in € - Price in €

ART.	DESCRIZIONE	CONF. PEZZI	MISURE MM		OLV	FUMÈ	B/INV	OCS	FE/ANT	PVD
			l	h						
840	Battente Paris <i>Paris knocker</i>	02	45	150	86,20	86,20	86,20	110,70	110,70	159,00
841	B - Battente Madrid <i>Madrid knocker</i>	02	90	105	83,30	83,30	83,30	103,10		168,50
	A - Battente Madrid <i>Madrid knocker</i>	02	120	120	93,20	93,20	93,20	119,00		178,50
842	Battente Leone <i>Leone knocker</i>	02	110	170	59,90	59,90	59,90			



art. 415 A/B/G



art. 416



art. 417



art. 420



art. 425 A/B



art. 426

Prezzi in € - Price in €

ART.	DESCRIZIONE	CONF. PEZZI	MISURE MM		OLV	FUMÈ	B/INV	BR. YEST	OCS	FE/ANT	PVD
			l	h							
415	B - Battente Leone con anello piccolo <i>Lion-headed knocker with ring</i>	02	90	150	41,00	41,00	41,00	43,95	59,50	62,50	119,00
	A - Battente Leone con anello medio <i>Lion-headed knocker with ring</i>	02	110	190	43,80	43,80	43,80	45,80	61,50	65,50	124,90
	G - Battente Leone con anello grande <i>Lion-headed knocker with ring</i>	01	150	260	137,24	137,24	137,24	139,24		145,35	
416	Borchia copridado ottagonale <i>Octagonal nut cover boss</i>	24	26	18	6,15	6,80	6,80		9,20		
417	Borchia copridado liscio <i>Smooth nut cover boss</i>	24	26	18	4,90	4,90	6,80		6,30		
425	B - Battente Esagono <i>Hexagonal knocker</i>	02	80	100	87,50	87,50	87,50	87,50	119,00		
	A - Battente Esagono <i>Hexagonal knocker</i>	02	90	120	93,20	93,20	93,20	93,20	122,90		
420	Battente Mano <i>Hand knocker</i>	02	50	110	46,00	46,00	46,00	46,00	53,50		
426	Battente Domus fissaggio con troncone passante <i>Domus knocker</i>	02	105	105	51,50						



maniglioni
pull-handles



I prezzi si intendono per singolo pezzo

Prezzi in € - Price in €

ART.	DESCRIZIONE	CONF. PEZZI	OLV	B/ANT	B/INV	FINITURA
810	Maniglione NINFEA c/rosetta coprivate Ø45 e sottoros. in nylon mm 260 <i>Pul Pull handles NINFEA with screw cover rosette Ø45 at pressure</i>	02	45,00	47,50	47,50	
810/A	Maniglione NINFEA con rosetta coprivate ad avvitare Ø50 mm 270 <i>Pul Pull handles NINFEA with screw cover rosette Ø50 to screw</i>	02	60,50	61,80	61,80	P/BIA
810/B	Maniglione NINFEA con rosetta Ø45 con viti in vista mm 260 <i>Pul Pull handles NINFEA with rosette Ø45 with hole screw</i>	02	58,00	59,00	59,00	
811	Maniglione GINESTRA c/rosetta copriv. Ø45 sottoros. in nylon mm 260 <i>Pul Pull handles GINESTRA with screw cover rosette Ø45 at pressure</i>	02	47,50	50,00	50,00	
811/A	Maniglione GINESTRA con rosetta coprivate ad avvitare Ø50 mm 270 <i>Pul Pull handles GINESTRA with screw cover rosette Ø50 to screw</i>	02	61,80	63,00	63,00	P/CH
811/B	Maniglione GINESTRA con rosetta Ø45 con viti in vista mm 260 <i>Pul Pull handles GINESTRA with rosette Ø45 with hole screw</i>	02	60,50	62,00	62,00	
812	Maniglione ROSA c/rosetta copriv. Ø45 sottoros. in nylon mm.260 <i>Pul Pull handles ROSA with screw cover rosette Ø45 at pressure</i>	02	54,80	57,50	57,50	
812/A	Maniglione ROSA con rosetta coprivate ad avvitare Ø50 mm 270 <i>Pul Pull handles ROSA with screw cover rosette Ø50 to screw</i>	02	66,00	68,40	68,40	P/BIA BLU
812/B	Maniglione ROSA con rosetta Ø45 con viti in vista mm 260 <i>Pul Pull handles ROSA with rosette Ø45 with hole screw</i>	02	65,00	67,50	67,50	
813	Maniglione CAMELIA c/rosetta copriv. Ø45 sottoros. in nylon mm 260 <i>Pul Pull handles CAMELIA with screw cover rosette Ø45 at pressure</i>	02	56,00	59,40	59,40	
813/A	Maniglione CAMELIA con rosetta coprivate ad avvitare Ø50 <i>Pul Pull handles CAMELIA with screw cover rosette Ø50 to screw</i>	02	68,40	71,00	71,00	P/CH ROSA
813/B	Maniglione CAMELIA con rosetta Ø45 con viti in vista <i>Pul Pull handles CAMELIA with rosette Ø45 with hole screw</i>	02	67,00	70,00	70,00	
814	Maniglione MARGOT c/rosetta copriv. Ø45 e sottoros. in nylon mm 260 <i>Pul Pull handles MARGOT with screw cover rosette Ø45 at pressure</i>	02	49,00	51,00	51,00	
814/A	Maniglione MARGOT con rosetta coprivate ad avvitare Ø50 mm 270 <i>Pul Pull handles MARGOT with screw cover rosette Ø50 to screw</i>	02	63,00	65,00	65,00	P/CH CRAQUELEE ¹
814/B	Maniglione MARGOT con rosetta Ø45 con viti in vista mm 260 <i>Pul Pull handles MARGOT with rosette Ø45 with hole screw</i>	02	62,00	64,00	64,00	



art. 2420



art. 2421



art. 2422

art. 446
art. 446/B

I prezzi si intendono per singolo pezzo

Prezzi in € - Price in €

ART.	DESCRIZIONE	CONF. PEZZI	OLV	OBG	B/INV	OCS
2420	Maniglione ELEGANT rosetta Ø45 c/viti in vista, interasse mm 228 <i>Pul Pull handles ELEGANT with rosette Ø45 with hole screw</i>	02	50,00		52,00	59,00
2420/A	Maniglione ELEGANT rosetta copriv. ad avvitare Ø50 interasse mm 228 <i>Pul Pull handles ELEGANT with screw cover rosette Ø50 to screw</i>	02	61,50		61,50	67,00
2421	Maniglione BON-BON con rosetta Ø45 con viti in vista mm 228 <i>Pul Pull handles BON-BON with rosette Ø45 with hole screw</i>	02	50,00		52,00	59,00
2421/A	Maniglione BON-BON con rosetta coprivate ad avvitare Ø50 mm 228 <i>Pul Pull handles BON-BON with screw cover rosette Ø50 to screw</i>	02	61,50		61,50	67,00
2422	Maniglione CLASSIC con rosetta Ø45 con viti in vista mm 228 <i>Pul Pull handles CLASSIC with rosette Ø45 with hole screw</i>	02	50,00		52,00	59,00
2422/A	Maniglione CLASSIC con rosetta coprivate ad avvitare Ø50 mm 228 <i>Pul Pull handles CLASSIC with screw cover rosette Ø50 to screw</i>	02	61,50		61,50	67,00
446	Maniglione VENICE c/rosetta copriv.Ø45 sottoros.in nylon mm 230 <i>Pul Pull handles VENICE with screw cover rosette Ø45 at pressure</i>	02	40,80	43,50	43,50	46,30
446/B	Maniglione VENICE con rosetta Ø45 con viti in vista interasse mm 230 <i>Pul Pull handles VENICE with rosette Ø45 with hole screw</i>	02	49,00	50,00	50,00	58,00



art. 145



art. 451

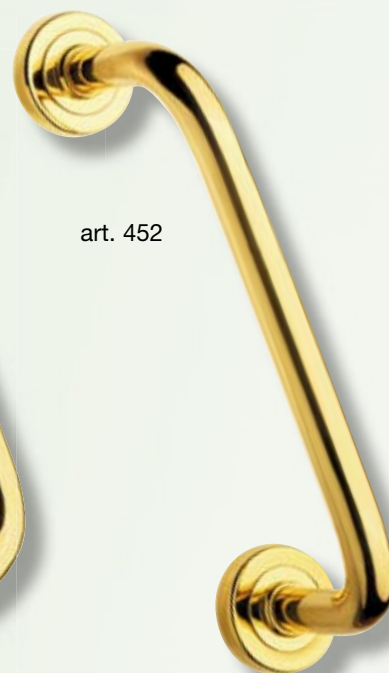

art. 452



art. 453



art. 454

Prezzi in € - Price in €

ART.	DESCRIZIONE	CONF. PEZZI	MISURE MM	OLV	FUMÈ
145	Maniglione "Azzurra" spostato con rosone ovale interasse mm 170 <i>Azzurra offset big handle, 170 mm center distance, with oval rosette</i>	02	190	45,00	48,00
451	Maniglione "Universal spostato" con rosetta copriv. Ø45 interasse mm 190 Ø6 <i>Universal offset pull handles with screw cover rose Ø45 center distance mm 190 Ø16</i>	02	200	60,00	
452	Maniglione "Universal dritto" con rosetta copriv. Ø45 interasse mm 200 Ø16 <i>Universal straight pull handle with rose Ø45, center distance mm 200 Ø16</i>	02	215	67,00	
453	Maniglione "Universal Ellisse" con rosone copriv. Ø45 interasse mm 220 Ø16 <i>Universal Ellipse pull handle with screw cover rose Ø45, center distance mm 200 Ø16</i>	02	235	70,50	
454	Maniglione "Persian" con ros. Ø50 interasse mm 170 <i>Persian pull handle with rose-window Ø50, center distance mm 170</i>	02	190	61,50	



art. 1025



art. 1026



art. 1027



art. 1028



art. 1030

art. SF01
SET DI FISSAGGIO

Prezzi in € - Price in €

ART.	DESCRIZIONE	CONF. PEZZI	MISURE MM	OLV	OBG	B/INV	OCS	OLV/OSV	OCR/OCS
1025	Maniglione "Linea" interasse mm 200 <i>"Linea" big handle center distance mm 200</i>	04	230	49,50	49,50		53,00		
1026	Maniglione "Linea-R" interasse mm 200 <i>Linea- R" big handles center distance mm 200</i>	04	230					54,85	58,80
1027	Maniglione "Zenit" interasse mm 200 <i>"Zenit " big handles center distance mm 200</i>	04	230	49,50	49,50		53,00		
1028	Maniglione "Zenit-R" interasse mm 200 <i>"Zenit- R" big handles" center distance mm 200</i>	04	230					54,85	58,80
1030	Maniglione "Sibilla" interasse mm 152 <i>Sibilla" big handles center distance mm 152</i>	06	175	30,20	31,80	31,80	33,60		



art. 1035



art. 1036



art. 1039

art. SF01
SET DI FISSAGGIO

Prezzi in € - Price in €

ART.	DESCRIZIONE	CONF. PEZZI	MISURE MM	OLV	OBG	OCS	OLV/OSV	OCR/OCS
1035	Maniglione "Zenea" interasse mm 200 <i>"Zenea" big handles center distance mm 200</i>	04	220	30,50	32,00	33,50		
1036	Maniglione "Zenea-R" interasse mm 200 <i>"Zenea-R" big handles center distance mm 200</i>	04	220				35,50	38,50
1039	Maniglione "Venus" interasse mm 240 <i>"Venus" big handles" center distance mm 240</i>	02	260	70,20		73,80		



art. 690



art. 691



art. 692

art. 694



art. 1020

Prezzi in € - Price in €

ART.	DESCRIZIONE	CONF. PEZZI	MISURE MM	OLV	OBG	BR. YEST	B/INV	PVD	OCS	OCR
690	Maniglione "Athos" spostato c/ros. avvit. mm 50 interasse mm 190 <i>"Athos" pull handles with rose mm 50 to screw, center distance mm 190</i>	02	240	54,00	57,00		57,00	90,00	60,00	63,00
691	Maniglione "Butterfly" c/ros. avvit. mm 50 interasse mm 215 <i>"Butterfly" pull handles with rose mm 50 to screw center distance mm 215</i>	02	260	65,00						
692	Maniglione "Antea" c/ros. coprivate mm 45 a pressione, interasse mm 190 <i>"Antea" pull handles with rose mm 45 screw cover center distance mm 190</i>	04	235	42,50	42,50		42,50		51,00	
694	Maniglione "Athos" dritto c/ros. avvit. mm 50 interasse mm 180 <i>"Athos" pull handles with rose mm 50 to screw, center distance mm 180</i>	02	230	45,00	48,00				51,00	
1020	Maniglione "Boston" c/ros. avvit. mm 50 interasse mm 170 <i>"Boston" pull handles with screw cover rose mm 50 to screw center distance mm 170</i>	02	220	84,00		84,00	84,00			



art. 140



art. 146



art. 447



art. 448



art. 450

Prezzi in € - Price in €

ART.	DESCRIZIONE	CONF. PEZZI	MISURE MM	OLV	B/INV	FUMÈ
140	Maniglione "Fiorentino" con rosette mm 45 ad avvitare <i>Fiorentino" pull handles with rose mm 45 to screw</i>	06	175			49,00
	Maniglione "Fiorentino" con rosette mm 45 ad avvitare <i>Fiorentino" pull handles with rose mm 45 to screw</i>	04	235			51,00
146	Maniglione "Impero" interasse mm 150 <i>"Impero" pull handles center distance mm 150</i>	02	260	77,00	77,00	77,00
447	Maniglione "Victoria" interasse mm 200 <i>"Victoria" pull handles center distance mm 200</i>	02	280	88,90		78,00
448	Maniglione "Savoy" interasse mm 150 interasse mm 180 <i>"Savoy" pull handles center distance mm 180</i>	02	260	86,50		86,50
450	Maniglione "Urano" interasse mm 200 <i>"Urano" pull handles center distance mm 200</i>	02	275	77,00		77,00



art. 693



art. 1800



art. 1802



art. 1804



art. 1806

Prezzi in € - Price in €

ART.	DESCRIZIONE	CONF. PEZZI	MISURE MM	OLV	OBG	OLV/OSV	OCR/OCS	OCS
693	Maniglione "Magnum" con rosette ad avvit. da mm 50, interasse mm 175 <i>"Magnum" pull handles, center distance mm 175</i>	01	220	67,50				
1800	Maniglione "Arceus" con rosette ad avvit. da mm 50, interasse mm 250 <i>"Arceus" pull handles with screw cover rose mm 50 to screw, center distance mm 250</i>	02	300	89,00	97,00			89,00
DISPONIBILE ANCHE NELLA VERSIONE SENZA ROSETTE								
1802	Maniglione "Amalthea" con rosette ad avvit. da mm 50 interasse mm 245 <i>"Amalthea" pull handles with screw cover rose mm 50 to screw - center distance mm 245</i>	02	300	89,00	97,00			89,00
1804	Maniglione "Parsifal" con rosette ad avvit. da mm 50 interasse mm 200 (fissaggio con troncone filettato da 8 ma) <i>"Parsifal" pull handles with screw cover rose mm 50 to screw - center distance mm 200</i>	02	320			101,50	108,50	
1806	Maniglione "Eclipse" con rosette avvitare mm 50 interasse mm 210 (fissaggio con troncone filettato da 8 ma) <i>"Eclipse" pull handles with screw cover rose mm 50 to screw - center distance mm 210</i>	02	265	54,00	57,00			60,00



art. 1808



art. 1810



art. 1811



art. 1812

art. SF02
SET DI FISSAGGIO

Prezzi in € - Price in €

ART.	DESCRIZIONE	CONF. PEZZI	MISURE MM	OLV	OBG	B/INV	OCS
1808	Maniglione "Sphaerae" dritto base mm 35 interasse mm 200 (fissaggio con troncone filettato da 8 ma) <i>"Sphaerae" pull handles, center distance mm 195</i>	02	230	60,00	64,50		
1810	Maniglione "Adamello" dritto con rosette ad avvitare da mm 50, interasse mm 200 (fissaggio con troncone filettato da 8 ma) <i>"Adamello" pull handles with screw cover rose mm 50 to screw, center distance mm 200</i>	02	260	75,00	79,50		
1811	Maniglione "Adamello" spostato con rosette ad avvitare da mm 50 interasse mm 195 (fissaggio con troncone filettato da 8 ma) <i>"Amalthea" pull handles with screw cover rose mm 50 to screw, center distance mm 195</i>	02	260	89,50	94,00		
1812	Maniglione "Garda" c/rosette mm 55 interasse mm 185 (fissaggio SF 02) <i>"Margherita" pull handles with rose mm 55, center distance mm 185</i>	02	240	124,90	124,90	124,90	136,80



art. 1813



art. 1814



art. 1815

Prezzi in € - Price in €

ART.	DESCRIZIONE	CONF. PEZZI	MISURE MM	OLV	OBG	OCR	OCS	PVD
1813	Maniglione "Benaco" con rosetta ad avvitare mm Ø45 interasse mm 170 (fissaggio con viti o troncone filettato da 8 ma) <i>"Garda" pull handles with screw cover rose mm Ø45 to screw, center distance mm 170</i>	02	215	71,00	71,00			
1814	Maniglione "Matrix" con rosetta ad avvitare da mm 55, interasse mm 230 (fissaggio con viti) <i>"Matrix" pull handles with screw cover rose mm 55 to screw, center distance mm 230</i>	02	280	83,00	84,50	99,00	94,00	138,00
1815	Maniglione "Spazio" interasse mm 200 <i>"Spazio" pull handles center distance mm 200</i>	02	230				51,00	

art. M1350

art. M2350

art. M3350

art. M4350

art. M5350

art. M6350

I prezzi indicati, si intendono per singolo pezzo o per singola coppia.

Prezzi in € - Price in €

ART.	DESCRIZIONE	CONF. PEZZI	MISURE MM	INOX SAT
M135	Maniglione Dritto Ø32 interasse mm 350 <i>Ø32 pull handle center distance mm 350</i>	02	380	43,50
M1C350	Coppia maniglioni dritti Ø32 interasse mm 350 <i>Ø32 pull handle couple center distance mm 350</i>	01	380	87,00
M2350	Maniglione spostato Ø32 interasse mm 350 <i>Ø32 pull handle center distance mm 350</i>	02	382	50,00
M2C350	Coppia maniglioni spostati Ø32 interasse mm 350 <i>Ø32 pull handle couple center distance mm 350</i>	01	382	100,00
M3350	Maniglione Ellisse Ø32 interasse mm 350 <i>Ø32 pull handle center distance mm 350</i>	02	382	52,00
M3C350	Coppia maniglioni Ellisse Ø32 interasse mm 350 <i>Ø32 pull handle couple center distance mm 350</i>	01	382	104,00
M4350	Maniglione Arco Ø32 interasse mm 350 <i>Ø32 pull handle center distance mm 350</i>	02	382	53,00
M4C350	Coppia maniglioni Arco Ø32 interasse mm 350 <i>Ø32 pull handle couple center distance mm 350</i>	01	382	106,00
M5350	Maniglione Sagomato Ø32 interasse mm 350 <i>Ø32 pull handle center distance mm 350</i>	02	382	53,00
M5C350	Coppia maniglioni Sagomati Ø32 interasse mm 350 <i>Ø32 pull handle couple center distance mm 350</i>	01	382	106,00
M6350	Maniglione Linea Ø32 interasse mm 350 <i>Ø32 pull handle center distance mm 350</i>	02	490	50,50
M6C350	Coppia maniglioni Linea Ø32 interasse mm 350 <i>Ø32 pull handle couple, center distance mm 350</i>	01	490	101,00

Il sistema di fissaggio standard, inserito nelle confezioni, è il kit 05 ed è incluso nel prezzo; per i maniglioni singoli al prezzo di listino va aggiunto il costo del kit prescelto.



art. M8500

art. M7350



art. M10350

art. KIT02



art. KIT03

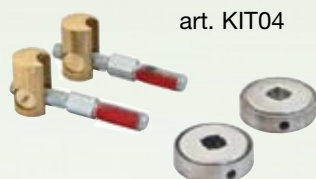

art. KIT04



art. KIT05

I prezzi indicati, si intendono per singolo pezzo o per singola coppia.

Prezzi in € - Price in €

ART.	DESCRIZIONE	CONF. PEZZI	MISURE MM	INOX SAT
M7350	Maniglione Sirio singolo Ø32 interasse mm 350 <i>Ø32 pull handle center distance mm 350</i>	02	370	57,50
M7C350	Coppia maniglioni Sirio Ø32 interasse mm 350 <i>Ø32 pull handle couple center distance mm350</i>	01	370	115,00
M8500	Maniglione Astrale singolo Ø32 interasse mm 500 <i>Ø32 pull handle center distance mm 500</i>	02	600	68,00
M8C500	Coppia maniglione Astrale Ø32 interasse mm 500 <i>Ø32 pull handle couple center distance mm 500</i>	01	600	136,00
M10350	Maniglione Linea Spostato singolo Ø32 interasse mm 350 <i>Ø32 pull handle center distance mm 350</i>	02	490	54,00
M10C350	Coppia maniglioni Linea spostato Ø32 interasse mm 350 <i>Ø32 pull handle couple center distance mm 350</i>	01	490	108,00
KIT02	Kit fissaggio maniglione singolo su vetro <i>Glass fixing kit (usare la foto scannerizzata)</i>	10		18,00
KIT03	Kit fissaggio maniglione singolo su legno o alluminio (passante) <i>Wood and alluminium fixing kit</i>	10		18,00
KIT04	Kit fissaggio maniglione singolo su alluminio (non passante) <i>alluminium fixing kit</i>	10		22,60
KIT05	Kit fissaggio maniglione accoppiato su vetro/legno/alluminio <i>Glass/wood/alluminium fixing kit (couple standard fixing)</i>	10		15,60

Il sistema di fissaggio standard, inserito nelle confezioni, è il kit 05 ed è incluso nel prezzo; per i maniglioni singoli al prezzo di listino va aggiunto il costo del kit prescelto.



accessori per mobili
accessories for furnitures

art. 88



art. 89



art. 91



art. 310



art. 316



art. 320



Prezzi in € - Price in €

ART.	DESCRIZIONE	CONF. PEZZI	MISURE MM Ø	OLV	OBV	OBG	OCR	OCS	NKS	B/INV	LB/ LNO	ARG/ ANT
88	Pomolino liscio <i>Furniture small knobs</i> <i>Möbelknopf</i> <i>Bouton de meuble</i>	50	22	2,78	3,34	3,64	3,30	3,52	3,77	2,78	2,70	
		50	28	3,64	4,20	4,37	4,15	4,33	4,72	3,77	3,56	
		30	34	5,23	5,82	6,08	5,58	5,95	6,43	5,48	5,18	
		30	40	6,94	7,50	7,92	7,62	7,80	7,92	7,32	6,85	
89	Pomolino ottagonale <i>Furniture small knobs</i> <i>Möbelknopf</i> <i>Bouton de meuble</i>	50	25	4,54	5,46		5,23	5,38				
		50	30	5,14	6,06		6,02	6,16				
		30	38	6,98	7,95		7,78	7,92				
		30	45	9,48	10,60		10,45	10,60				
91	Pomolino sferico c/base <i>Furniture small knobs</i> <i>Möbelknopf</i> <i>Bouton de meuble</i>	50	18	2,62	3,34	3,64	3,30	3,52	3,77		2,70	
		50	22	3,34	3,90	4,20	3,85	4,03	4,37		3,22	
		30	26	4,46	4,93	5,23	5,06	5,27	5,57		4,24	
		30	30	6,34	6,85	7,15	6,94	7,20	7,45		6,17	
310	Pomolino c/base <i>Furniture small knobs</i> <i>Möbelknopf</i> <i>Bouton de meuble</i>	50	20	2,66	3,22	3,39	3,13	3,26	3,68	2,66	2,58	
		30	25	3,60	4,15	4,42	4,15	4,33	4,72	3,65	3,52	
		30	30	5,23	5,74	6,16	5,78	6,00	6,12	5,25	5,06	
		30	35	6,72	7,41	7,62	7,41	7,54	8,00	6,86	6,77	
316	Pomolino ottone <i>Furniture small knobs</i> <i>Möbelknopf</i> <i>Bouton de meuble</i>	50	12	3,30			3,67	3,74	4,04			
		30	15	3,60			3,82	3,89	4,19			
		20	18	4,05			4,12	4,19	4,49			
320	Pomolino palla c/base <i>Furniture small knobs</i> <i>Möbelknopf</i> <i>Bouton de meuble</i>	50	15	2,10	2,57	2,83	2,57	2,70	3,00		1,93	3,00
		50	20	2,70	3,30	3,52	3,17	3,39	3,73		2,57	3,73
		30	25	4,16	4,63	5,05	4,72	4,92	5,05		3,98	5,05
		30	30	6,25	6,81	7,20	6,90	7,07	7,20		6,13	7,20
		20	35	8,74	9,50	9,68	9,46	9,60	10,06		8,78	10,06

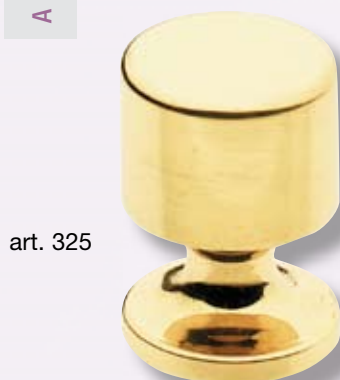

art. 325



art. 330



art. 335



art. 340



art. 456



art. 457

Prezzi in € - Price in €

ART.	DESCRIZIONE	CONF. PEZZI	MISURE MM Ø	OLV	OBV	OBG	FUMÈ	OCR	OCS	NKS	ARG/ANT	LB/LNO	B/YEST
325	Pomolino cilindrico c/base <i>Furniture small knobs</i> <i>Möbelknopf</i> <i>Bouton de meuble</i>	50	16	2,32	2,87			2,83	2,96	3,25			
		50	20	2,96	3,55			3,51	3,64	3,98			
		30	25	4,54	5,22			5,27	5,18	5,74			
330	Pomolino testa piana <i>Furniture small knobs</i> <i>Möbelknopf</i> <i>Bouton de meuble</i>	50	17	2,10	2,57			2,48	2,66	2,74	2,74	1,92	
		50	20	2,45	2,96			2,87	3,09	3,22	3,22	2,48	
		50	25	3,10	3,68			3,64	3,77	3,90	3,90	3,19	
		30	32	4,59	5,22			5,22	5,35	5,48	5,48	4,52	
335	Pomolino testa bombata <i>Furniture small knobs</i> <i>Möbelknopf</i>	50	17	2,19	2,62		2,87	2,62	2,74	2,92	2,85	1,98	
		50	20	2,70	3,26		3,43	3,17	3,30	3,47	3,38	2,57	
		50	25	3,43	4,03		4,24	3,98	4,07	4,20	4,14	3,35	
		30	32	5,02	5,65		5,83	5,62	5,78	5,87	5,70	4,97	
340	Pomolino sagomato <i>Furniture small knobs</i> <i>Möbelknopf</i> <i>Bouton de meuble</i>	50	20	2,45	2,92	3,17		3,05	3,13		3,20	2,06	
		50	25	3,52	4,03	4,24		4,07	4,20		4,26	3,30	
		30	30	4,88	5,35	5,74		5,62	5,74		5,78	4,67	
		30	35	6,94	7,62	7,79		7,62	7,88		7,69	7,79	
456	Pomolino sagomato c/base <i>Furniture small knobs</i> <i>Möbelknopf</i> <i>Bouton de meuble</i>	50	20	2,19	2,66		3,00	2,66	2,87		3,00		3,00
		30	25	3,34	3,86		4,20	3,90	4,07		4,20		4,20
		30	30	4,97	5,61		5,83	5,57	5,74		5,83		5,83
		30	35	6,25	6,94		7,20	6,90	7,07		7,20		7,20
457	Pomolino smile <i>Furniture small knobs</i> <i>Möbelknopf</i> <i>Bouton de meuble</i>	50	12	2,06	2,49			2,49	2,62	2,96		1,85	

art. 458



art. 460



art. 461



art. 462



art. 463



art. 464



Prezzi in € - Price in €

ART.	DESCRIZIONE	CONF. PEZZI	MISURE MM Ø	OLV	OBV	OBG	OCR	OCS	NKS	LB/LNO
458	Pomolino fungo <i>Furniture small knob</i> <i>Möbelknopf</i> <i>Bouton de meuble</i>	50	16	2,15	2,57	2,83	2,57	2,62	2,95	1,94
		50	20	2,62	3,13	3,38	3,17	3,26	3,64	2,45
		50	25	3,60	4,15	4,45	4,15	4,33	4,72	3,52
		30	30	5,14	5,79	5,95	5,95	6,12	6,26	5,10
460	Pomolino globo <i>Furniture small knobs</i> <i>Möbelknopf</i> <i>Bouton de meuble</i>	50	15	1,98			2,45	2,57		1,76
		50	20	2,62			3,13	3,25		2,45
		50	25	3,73			4,24	4,45		3,60
		30	30	5,62			6,25	6,38		5,62
		20	35	8,00			8,78	8,90		8,09
461	Pomolino rigato <i>Furniture small knobs</i> <i>Möbelknopf</i> <i>Bouton de meuble</i>	50	14	2,18	2,57		2,66	2,78	2,91	2,01
		50	18	2,66	3,04		3,17	3,30	3,73	2,49
		50	22	3,60	3,98		4,15	4,28	4,63	3,51
462	Pomolino planet <i>Furniture small knobs</i> <i>Möbelknopf</i> <i>Bouton de meuble</i>	50	20	2,70			3,21	3,34	3,73	2,57
		50	25	3,85			4,20	4,45	4,88	3,68
		30	30	5,74			6,16	6,42	6,85	5,65
463	Pomolino rodos <i>Furniture small knobs</i> <i>Möbelknopf</i> <i>Bouton de meuble</i>	50	24	3,26			3,77	3,99	4,16	3,00
464	Pomolino fly <i>Furniture small knobs</i> <i>Möbelknopf</i> <i>Bouton de meuble</i>	50	15	2,19	2,66	2,92	2,70	2,78	3,13	2,14



art. 465



art. 467



art. 468



art. 469



art. 470



art. 471

Prezzi in € - Price in €

ART.	DESCRIZIONE	CONF. PEZZI	MISURE MM Ø	OLV	OBV	OBG	FUMÈ	OCR	OCS	NKS	B/INV	LB/LNO	B/YEST
465	Pomolino ipos <i>furniture small knobs</i> <i>Möbelknopf</i> <i>Bouton de meuble</i>	50	17	2,19	2,45			2,70	2,78	3,13		2,14	
467	Pomolino bottone <i>Furniture small knobs</i> <i>Möbelknopf</i> <i>Bouton de meuble</i>	50	20	2,62		3,38		2,70	2,92		2,32		
		50	25	3,22		4,03		3,64	3,90		3,25		
		30	30	4,72		5,65		5,18	5,48		4,72		
468	Pomolino real <i>Furniture small knobs</i> <i>Möbelknopf</i> <i>Bouton de meuble</i>	50	25	2,96			3,73						
		30	30	3,98			4,72						
469	Pomolino marte <i>Furniture small knobs</i> <i>Möbelknopf</i> <i>Bouton de meuble</i>	50	20	2,70				3,17	3,34			2,57	
		50	25	3,30				3,64	3,90			3,22	
		30	30	5,26				5,65	5,86			5,09	
470	Pomolino quenn <i>Furniture small knobs</i> <i>Möbelknopf</i> <i>Bouton de meuble</i>	30	25	5,09			6,00						6,00
		30	32	6,80			7,76						7,76
471	Pomolino saturno <i>Furniture small knobs</i> <i>Möbelknopf</i> <i>Bouton de meuble</i>	50	15	2,19		3,00		2,66	2,83	3,00			1,94

art. 2430



art. 2431



art. 2432



art. 2434



art. 2433



Prezzi in € - Price in €

ART.	DESCRIZIONE	CONF. PEZZI	MISURE MM		OLV	OCR	OCS	LB/ LNO
2430	Pomolino quadro <i>Furniture small knobs</i> <i>Möbelknopf</i> <i>Bouton de meuble</i>	30	Q.20	H 17	6,29	6,95	7,42	
		30	Q.25	H 20	7,87	8,54	8,98	
2431	Pomolino quadro <i>Furniture small knobs</i> <i>Möbelknopf</i> <i>Bouton de meuble</i>	30	Q.12	H 25	5,95	6,50	6,96	
		30	Q.15	H 30	6,64	7,46	7,64	
2432	Pomolino quadro <i>Furniture small knobs</i> <i>Möbelknopf</i> <i>Bouton de meuble</i>	30	Q.14	H 14	5,49	6,04	7,78	
		30	Q.18	H 18	6,68	7,24	7,55	
		30	Q.25	H 25	7,78	8,32	8,78	
2433	Pomolino tondo <i>Furniture small knobs</i> <i>Möbelknopf</i> <i>Bouton de meuble</i>	30	Ø25	H 18	3,12	3,72	3,86	3,03
		30	Ø25	H 28	3,95	4,55	4,70	3,86
2434	Pomolino tondo <i>Furniture small knobs</i> <i>Möbelknopf</i> <i>Bouton de meuble</i>	30	Ø20	H 15	2,64	3,15	3,30	2,55
		30	Ø20	H 25	3,28	3,80	3,96	3,22



art. 472



art. 473



art. 600



art. 601



art. 605



art. 606

Prezzi in € - Price in €

ART.	DESCRIZIONE	CONF. PEZZI	MISURE MM	OLV	OBG	P/BIA	P/CH	OCR	OCS	NKS	LB/ LNO
472	Pomolino saturno con base <i>Furniture small knobs</i> <i>Möbelknopf</i> <i>Bouton de meuble</i>	50	Ø18	2,48	3,30			3,00	3,13	3,30	2,20
473	Pomolino <i>Furniture small knobs</i> <i>Möbelknopf</i> <i>Bouton de meuble</i>	50	Ø18	2,45	3,21			2,95	3,08	3,42	2,32
600	Pomolino ovale in porcellana champagne senza base <i>Champagne porcelain oval small knob without base.</i>	25	34x25				4,06				
601	Pomolino ovale in porcellana bianca senza base <i>White porcelain oval small knob whitout base</i>	25	34x25				4,06				
605	Pomolino rotondo in porcellana bianca senza base <i>White porcelain round small knob without base</i>	25	Ø26				3,05				
		25	Ø30				3,05				
606	Pomolino rotondo in porcellana champagne senza base <i>Champagne porcelain round small knob without base</i>	25	Ø26				3,56				
		25	Ø30				3,56				



art. 602



art. 603



art. 607



art. 610



art. 608



art. 611

Prezzi in € - Price in €

ART.	DESCRIZIONE	CONF. PEZZI	MISURE MM	P/CH Rosa	P/BIA Blu	P/BIA Rosa	B/ANT	NIK	OL
602	Pomolino ovale in porcellana champagne c/fiore rosa senza base <i>Champagne porcelain oval small knob with rosa flower without base</i>	25	34x25	4,06					
603	Pomolino ovale in porcellana bianca c/fiore blu senza base <i>White porcelain oval small knob with blu flower without base</i>	25	34x25		4,06				
607	Pomolino rotondo porcellana champagne c/fiore rosa senza base <i>Champagne porcelain round small knob with rosa flower without base</i>	25	Ø30	3,72					
608	Pomolino rotondo in porcellana bianca c/fiore rosa senza base <i>White porcelain round small knob whit rosa flower without base</i>	25	Ø30			3,72			
610	Pomolino rotondo in porcellana bianca c/fiore blu senza base <i>White porcelain round small knob with blue flower without base</i>	25	Ø30		3,72				
611	Base per pomolini in porcellana a richiesta <i>Porcelain small knobs base</i>	50	Ø18				1,02	1,02	0,85



art. 609



art. 1612



art. 1613



art. 1615



art. 1614



art. 611

Prezzi in € - Price in €

ART.	DESCRIZIONE	CONF. PEZZI	MISURE MM	P/BIA Oro	P/BIA Ibisco	P/BIA Marron	OL	B/ANT	NIK
609	Pomolino rotondo in porcellana bianca decorazione oro senza base <i>White porcelain round small knob with gold line without base</i>	25	Ø30	3,72					
1612	Pomolino ovale in porcellana bianca c/fiore di ibisco senza base <i>White porcelain oval small knob with ibisco flower without base</i>	25	34x25		4,06				
1613	Pomolino rotondo in porcellana bianca c/fiore di ibisco senza base <i>White porcelain round small knob with ibisco flower without base</i>	25	Ø26		3,72				
		25	Ø30		3,72				
1614	Pomolino ovale in porcellana bianca c/fiore marron senza base <i>White porcelain oval small knob with brown flower without base</i>	25	34x25			4,06			
1615	Pomolino rotondo in porcellana bianca c/fiore marron senza base <i>White porcelain round small knob with brown flower without base</i>	25	Ø26			3,72			
		25	Ø30			3,72			
611	Base per pomolini in porcellana a richiesta <i>Porcelain small knobs base</i>	50	Ø18				0,85	1,02	1,02



art. 1616



art. 1617



art. 1618



art. 1619



art. 1620



art. 1621

Prezzi in € - Price in €

ART.	DESCRIZIONE	CONF. PEZZI	MISURE MM	P/BIA IBISCO	P/BIA Mela Verde	P/BIA Fiori di campo	P/BIA BLU	P/BIA Fiore Miosotis
1616	Pomolino ovale in porcellana champagne c/fiore di ibisco senza base <i>Champagne porcelain oval small knob with ibisco flower without base</i>	25	34x25	4,06				
1617	Pomolino rotondo in porcellana champagne c/fiore ibisco senza base <i>Champagne porcelain round small knob with ibisco flower without base</i>	25	Ø26	3,72				
		25	Ø30	3,72				
1618	Pomolino rotondo in porcellana bianca decorazione mela verde senza base <i>White porcelain round small knob with green apple without base</i>	25	Ø26		3,72			
		25	Ø30		3,72			
1619	Pomolino rotondo in porcellana champagne c/fiore di campo senza base <i>Champagne porcelain round small knob with field flower without base</i>	25	Ø26			3,72		
		25	Ø30			3,72		
1620	Pomolino ovale in porcellana bianca c/fiore blu senza base <i>Oval small knob white porcelain with blue flower without base</i>	25	34x25				4,06	
1621	Pomolino ovale in porcellana bianca c/fiore miosotis senza base <i>Oval small knob white porcelain with miosotis flower without base</i>	25	34x25					4,06



art. 1623



art. 1624



art. 1625



art. 1626



art. 1627



art. 1628



art. 1629

Prezzi in € - Price in €

ART.	DESCRIZIONE	CONF. PEZZI	MISURE MM	P/CH	P/BIA B	P/CH Rosa	P/BIA Blu	P/BIA Marron	P/CH Ibisco	B/ANT	OLV
1623	Pendente snodato in porcellana champagne su rosetta Ø25 <i>Champagne porcelain</i>	25	Ø20x56	11,70							
1624	Pendente snodato in porcellana bianca su rosetta Ø25 <i>White porcelain</i>	25	Ø20x56		11,70						
1625	Pendente snodato in porcellana champagne c/fiore rosa su rosetta Ø25 <i>Champagne porcelain with rosa flower</i>	25	Ø20x56			11,70					
1626	Pendente snodato in porcellana bianca con fiore blu su rosetta Ø25 <i>White porcelain with blue flower</i>	25	Ø20x56				11,70				
1627	Pendente snodato in porcellana bianca con fiore marron su rosetta Ø25 <i>White porcelain with brown flower</i>	25	Ø20x56					11,70			
1628	Pendente snodato in porcellana champagne c/fiore di lbisco su rosetta Ø25 <i>Champagne porcelain with ibisco flower</i>	25	Ø20x56						11,70		
1629	Pendente snodato in ottone, su rosetta Ø25	25	Ø15x60							11,85	12,50

art. 1400



art. 1401



art. 1402



art. 1403



Prezzi in € - Price in €

ART.	DESCRIZIONE	CONF. PEZZI	MISURE MM	Z/ANT P/BIA	Z/CSAN P/BIA	Z/ANT P/CH	Z/ANT Fiore Rosa
1400	Maniglia zama anticata/porcellana bianca, interasse mm 74, lunghezza mm 126 <i>Antique small handle/white porcelain, center distance mm 74, lenght mm 126</i>	25	125	5,42			
1401	Maniglia zama cromo satinata/porcellana bianca interasse mm 74, lunghezza mm 126 <i>Chrome matt small handle/white porcelain, center distance mm 74, lenght 126</i>	25	125		5,76		
1402	Maniglia zama anticata/porcellana champagne, interasse mm 74, lunghezza mm 126 <i>Antique small handle/ champagne porcelain, center distance mm 74, lenght mm.126</i>	25	125			5,42	
1403	Maniglia zama anticata/porcellana champagne c/fiore rosa interasse mm 74, lunghezza mm 126 <i>Zamak antique small handle/champagne porcelain with rose flower, center distance mm 74, lenght mm 126</i>	25	125				6,44



art. 1404



art. 1405



art. 1406



art. 1407

Prezzi in € - Price in €

ART.	DESCRIZIONE	CONF. PEZZI	MISURE MM	Z/ANT	Z/ANT	Z/ANT	Z/ANT
				Fiore Miosotis	Fiore Blu	Mela Verde	Fiore Marron
1404	Maniglietta anticata porcellana bianca c/ fiore miosotis interasse mm 74, lunghezza mm 126 <i>Antique small handle/white porcelain green flower center distance mm 74, lenght mm 126</i>	25	125	6,44			
1405	Maniglietta anticata porcellana bianca fiore blu interasse mm 74, lunghezza mm 126 <i>Small handle/white porcelain blue flower center distance 74, lenght mm 126</i>	25	125		6,44		
1406	Maniglietta anticata/porcellana bianca dec. mela verde interasse mm 74, lunghezza mm 126 <i>Antique small handle white porcelain with green apple center distance mm 74, length mm 126</i>	25	125			6,44	
1407	Maniglietta anticata/porcellana bianca c/ fiore marrone interasse mm 74, lunghezza mm 126 <i>Antique small handle/white porcelain with brown flower center distance mm 74, lenght mm 126</i>	25	125				6,44



Prezzi in € - Price in €

ART.	DESCRIZIONE	CONF. PEZZI	MISURE MM	Z/ANT P/BIA	Z/ANT	Z/ANT	Z/ANT	Z/ANT	Z/ANT	Z/ANT
					AN P/CH	P/CH Fiore Rosa	P/BIA Fiore Miosotis	P/BIA Fiore Blu	P/BIA Mela Verde	P/BIA Fiore Marron
1410	Maniglietta zama anticata/porcellana bianca, interasse mm 96, lunghezza mm 116 <i>Antique small handle/white porcelain, center distance mm 96, lenght mm 116</i>	25	125	6,44						
1411	Maniglietta zama anticata/porcellana champagne, interasse mm 96, lunghezza mm 116 <i>Antique small handle/champagne porcelain, center distance mm 96, lenght mm 116</i>	25	125	6,44						
1412	Maniglietta zama anticata/porcellana champagne c/ fiore rosa interasse mm 96, lunghezza mm 116 <i>Zamak antique small handle/champagne porcelain with rose flower center distance mm 96, lenght mm 116</i>	25	125	6,44						
1413	Maniglietta anticata porcellana bianca c/fiore miosotis interasse mm 96, lunghezza mm 116 <i>Antique small handle/white porcelain green flower center distance mm 96, lenght mm 116</i>	25	125	6,44						
1414	Maniglietta anticata porcellana bianca fiore blu interasse mm 96, lung. mm 116 <i>Small handle/white porcelain blue flower center dist. Mm 96, lenght mm 116</i>	25	125	6,44						
1415	Maniglietta anticata/ porcellana bianca dec. mela verde interasse mm 96, lunghezza mm 116 <i>Antique small handle white porcelain with green apple, center dist. mm 96, lenght mm 116</i>	25	125	6,44						
1416	Maniglietta anticata/porcellana bianca c/fiore marrone interasse mm 96, lunghezza mm 116 <i>Antique small handle/white porcelain with brown flower, center distance mm 96, lenght 116</i>	25	125	6,44						



art. 12



art. 13



art. 14

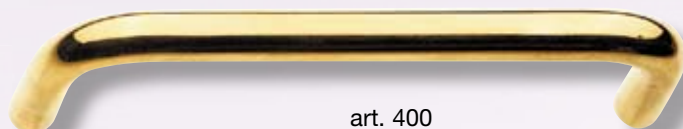

art. 400

Prezzi in € - Price in €

ART.	DESCRIZIONE	CONF. PEZZI	MISURE MM	OL	OBR	OCR	OCS	Z/OTT	Z/CR	Z/CS
12	Maniglia liscia per mobili <i>Furniture small handle</i>	50	80	1,60	1,80	2,24	2,69			
		50	100	1,80	2,02	2,48	2,92			
		50	120	2,02	2,24	2,70	3,14			
		50	140	2,24	2,46	2,92	3,36			
13	Maniglia scanalata <i>Grooved small handle</i>	30	140	3,62	4,18	4,30	5,10			
14	Maniglia rigata <i>Fluted small handle</i>	30	140	3,62	4,18	4,30	5,10			
400	Maniglia bastoncino <i>"Small stick" small handle</i>	24	Ø8x64					3,70	3,70	3,70
		24	Ø8x96					4,70	4,35	4,35
		24	Ø8x128					5,20	4,65	4,65

art. 485



art. 486



art. 487



art. 1417



art. 1418



Prezzi in € - Price in €

ART.	DESCRIZIONE	CONF. PEZZI	MISURE MM	OL	OBR	B/INV	OLV	OCR	OCS	OBG
485	Maniglia conchiglia rigata <i>Fluted shell furniture small handle</i>	25	84x36			11,48	9,78			
486	Maniglia conchiglia liscia <i>Smooth shell small handle</i>	25	84x36			11,65	9,95			
487	Maniglia ad incasso <i>Small handle</i>	25	50x40	6,85	7,27			8,56	9,40	
1417	Maniglia "pratica" interasse mm 125 <i>Furniture small handle "pratica" center distance mm 125</i>	25	Ø10x155				12,69	14,58	14,58	
1418	Maniglia "ponte" interasse mm 64x92 mm e 96x120 mm <i>Furniture small handle "bridge" center distance mm 64</i>	25	64x92				3,32	4,55	4,55	3,98
		25	96x120				5,44	6,65	6,65	5,68



art. 1419



art. 1422



art. 1420



art. 1421



art. 1423

Prezzi in € - Price in €

ART.	DESCRIZIONE	CONF. PEZZI	MISURE MM	INOX SAT	LNO
1419	Maniglia per mobili in acciaio satinato <i>Fumitures small handle</i>	25	Ø10x96	6,30	
		25	Ø10x128	6,60	
		25	Ø10x160	6,90	
		25	Ø10x192	7,50	
		25	Ø10x256	9,50	
		25	Ø10x320	12,20	
1420	Maniglia per mobili in acciaio satinato <i>Fumitures small handle</i>	25	Ø10x96	6,60	
		25	Ø10x128	7,10	
		25	Ø10x160	7,70	
		25	Ø10x192	8,50	
		25	Ø10x256	10,45	
		25	Ø10x320	11,60	
1421	Maniglia "rustica" in ferro laccato Interasse mm 150x185, lunghezza tot. mm 185 <i>Fumitures small handle-black iron</i>	24	150		8,40
1422	Maniglia "ritorta" in ferro laccato nero <i>Fumitures small handle, black iron</i>	12	115		8,16
		12	145		9,94
		12	220		19,10
1423	Maniglia ad anello "ritorta in ferro laccato nero <i>Fumitures small handle black iron</i>	25	Ø30		5,08
		25	Ø40		5,78



art. 1



art. 2



art. 3

Prezzi in € - Price in €

ART.	DESCRIZIONE	CONF. PEZZI	MISURE MM	OL	OBR	NIK
1	Cerniera fresata piana <i>Flat milled hinge</i>	24	25x25	0,98	1,28	1,56
		24	30x25	0,98	1,28	1,56
		24	30x30	1,02	1,30	1,63
		24	35x30	1,10	1,38	1,66
		24	35x35	1,16	1,41	1,71
		24	40x30	1,18	1,43	1,73
		24	40x35	1,22	1,47	1,77
		24	40x40	1,48	1,73	2,03
		24	50x30	1,51	1,89	2,07
		24	50x40	1,65	2,00	2,32
		24	50x50	1,98	2,21	2,49
		24	60x50	2,27	2,66	2,88
		24	70x55	2,68	3,19	3,50
2	Cerniera fresata ½ zancata <i>Milled clamped half-hinge</i>	24	35x35	1,24	1,48	1,78
		24	40x35	1,44	1,68	1,98
		24	40x40	1,72	1,85	2,31
		24	50x40	1,76	2,10	2,38
		24	50x50	2,18	2,58	2,75
		24	60x50	2,48	2,92	3,06
		24	70x55	5,55	6,29	6,60
3	Cerniera fresata doppia zancata <i>Milled double clamped hinge</i>	24	35x35	1,34	1,59	1,90
		24	40x35	1,40	1,70	2,00
		24	40x40	1,72	2,10	2,36
		24	50x40	2,05	2,44	2,66
		24	50x50	2,57	3,05	3,27
		24	60x50	2,98	3,54	3,70
		24	70x55	6,07	6,67	6,89

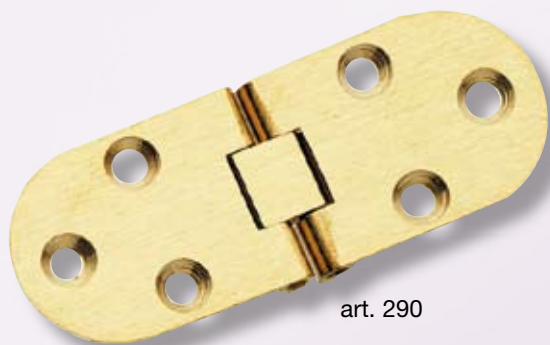

art. 290



art. 291

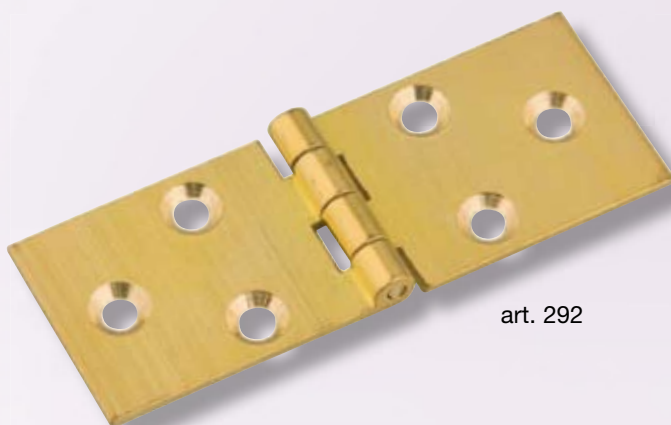

art. 292

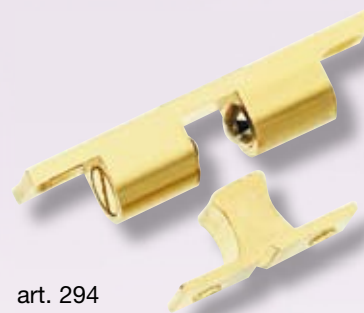

art. 294



art. 293

Prezzi in € - Price in €

ART.	DESCRIZIONE	CONF. PEZZI	MISURE MM	OL	OBR	NIK	SAT VERN.	BRONZO VERN.	NICK SAT
290	Cerniera a biscotto con fermo <i>Biscuit hinge with stop</i>	24	30x68				3,66	4,45	4,45
		24	30x80				3,66	4,45	4,45
291	Cerniera biscotto c/ala quadra senza fermo <i>Biscuit hinge without stop</i>	24	30x80	2,52	2,88	3,08			
292	Cerniera biscotto c/ala quadra senza fermo <i>Biscuit hinge without stop</i>	24	30x80	2,52	2,88	3,08			
293	Cerniera tonda per ribaltina <i>Furniture small hinge</i>	100	30x47	1,80	2,01	2,40			
294	Cricchetto a due sfere <i>Two ball clamping</i>	50	8x44	1,92	2,28	2,48			
		50	9x49	2,16	2,66	2,84			
		50	11x60	3,00	3,52	3,66			
		50	13x70	4,14	4,69	4,80			



art. 295



art. 296



art. 301



art. 302/BT



art. 303



art. 304/BT

Prezzi in € - Price in €

ART.	DESCRIZIONE	CONF. PEZZI	MISURE MM	OL	OBR	NIK
295	Cerniera piana con piramidi canotto liscio (mano dx/sx) <i>Furniture small hinge With pyramidal - right/left hand</i>	24	40x40	3,08	3,38	4,12
		24	50x40	3,48	3,82	4,51
		24	60x40	4,16	4,54	5,20
296	Cerniera doppia zanca con piramidi canotto liscio (mano dx/sx) <i>Furniture small hinge with pyramidal - right and left hand</i>	24	40x40	3,44	3,78	4,48
		24	50x40	3,90	4,30	4,94
		24	60x40	4,62	5,05	5,66
301	Cerniera rigata piana con piramidi (mano dx/sx) <i>Furniture small hinge with pyramidal, right/left hand</i>	24	40x40	3,00	3,30	4,04
		24	50x40	3,34	3,64	4,38
		24	60x40	3,74	4,07	4,77
302/BT	Cerniera rigata piana con piramidi ala stondata (mano dx/sx) <i>Furniture small hinge with pyramidal, right/left hand</i>	24	40x40	3,26	3,58	4,34
		24	50x40	3,62	3,93	4,69
		24	60x40	4,19	4,54	5,26
303	Cerniera rigata doppia zanca c/piram. (mano dx/sx) <i>Double clamped ruled hinge right and left hand</i>	24	40x40	3,38	3,73	4,43
		24	50x40	3,85	4,20	4,90
		24	60x40	4,42	4,80	5,45
304/BT	Cerniera piana con piramidi canotto liscio ala stondata (mano dx / sx) <i>Furniture small hinge with pyramidal, right/left hand</i>	24	40x40	3,08	3,65	4,42
		24	50x40	3,77	4,12	4,80
		24	60x40	4,03	4,42	5,06



art. 430



art. 431



art. 434



art. 435



art. 436



art. 437



art. 438

Prezzi in € - Price in €

ART.	DESCRIZIONE	CONF. PEZZI	MISURE MM	OL	OBR	NIK
430	Cerniera a sfilare piana (mano dx/sx) <i>Furniture small hinge right and left hand</i>	48	40x40	1,72	1,97	2,75
		48	50x40	2,02	2,32	3,05
431	Cerniera a sfilare doppia zancata (mano dx/sx) <i>Furniture small hinge right and left hand</i>	48	40x40	1,76	2,02	2,80
		48	50x40	2,06	2,36	3,10
434	Cerniera a sfilare piana c/piramidi e ala stondata (mano dx/sx) <i>Furniture small hinge with capitals right and left hand</i>	24	50x40	3,13	3,43	
435	Cerniera a sfilare doppia zancata c/piramidi e ala stondata (mano dx/sx) <i>Furniture small hinge with capitals right and left hand</i>	24	50x40	3,22	3,52	
436	Cerniera a sfilare piana ala stondata (mano dx/sx) <i>Furniture small hinge right and left hand</i>	48	50x40	3,00	3,30	
437	Cerniera piana c/premontaggio tondo <i>Furniture small hinge with round pre-mounting</i>	60	40x40	2,46	3,09	3,65
		60	50x40	2,95	3,58	4,20
438	Cerniera zancata c/premontaggio tondo <i>Furniture small hinge with round pre-mounting</i>	60	40x40	2,70	3,20	
		60	50x40	3,23	3,92	

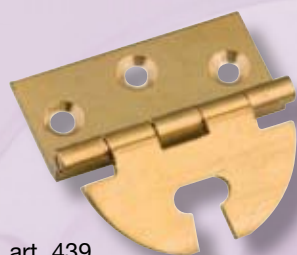

art. 439



art. 439SM



art. 439BT



art. 439P



art. 492



art. 493



art. 494



art. 535

Prezzi in € - Price in €

ART.	DESCRIZIONE	CONF. PEZZI	MISURE MM	OL	OBR	NIK	
439	Cerniera c/asola <i>Furniture small hinge</i>	<i>collo 0</i>	100	40X40	1,54	1,80	2,08
		<i>collo 8</i>	100	40X40	1,58	1,85	2,13
		<i>collo 10</i>	100	40X35	1,48	1,72	2,00
		<i>collo 13</i>	100	40x35	1,58	1,80	2,08
439SM	Cerniera c/asola e collo smussato <i>Furniture small hinge</i>	<i>collo 0</i>	100	40X40	1,85	2,10	2,34
439BT	Cerniera tonda con asola <i>Furniture small hinge with round wing</i>	<i>collo 0</i>	100	40X40	1,88	2,14	2,42
439P	Piastrina di fissaggio per cerniere: Art.439 - Art.439SM - Art.439BT <i>Pre-mounting base for: Art.439 - Art.439SM - Art. 439B</i>	200		0,60	0,69	1,02	
492	Cerniera tonda con cave <i>Furniture small hinge with round wing</i>			40x40	1,59	1,85	2,12
				50x50	2,18	2,48	2,65
493	Cerniera tonda con ala tagliata <i>Furniture small hinge with round wing</i>	200		35x35	1,54	1,76	2,06
494	Cerniera tonda con 6 fori <i>Furniture small hinge with round wing</i>	200		35x35	1,42	1,63	1,92
		200		40x40	1,54	1,80	2,06
		200		50x50	2,14	2,44	2,66
535	Cerniera cilindriche a scomparsa <i>Extractable hinge</i>	24		Ø10	4,42		4,95
		24		Ø12	4,42		4,95
		24		Ø14	4,67		5,21
		24		Ø16	5,62		6,15
		24		Ø18	6,48		7,00
		24		Ø24	12,16		12,72



art. 5



art. 10 a



art. 10 b



art. 15



art. 10 c

Prezzi in € - Price in €

ART.	DESCRIZIONE	CONF. PEZZI	MISURE MM	OL	OBR
5	Cerniera barocco piana ala tonda (mano dx/sx) <i>Baroque furniture small hinge with round wing, right and left hand</i>	24	55x40x65	2,30	2,30
10 A-B-C	Cerniera barocco piana ala quadra (mano dx/sx) <i>Baroque furniture small hinge right and left hand</i>	24	A 65x55x90	4,15	4,15
		24	B 55x40x65	2,26	2,26
		24	C 45x35x56	2,15	2,15
15 A-B	Cerniera barocco zancata ala quadra (mano dx/sx) <i>Clamp small hinge right and left hand</i>	24	A 65x55x90	4,95	4,95
		24	B 55x40x65	2,30	2,30

note



ganci per quadri e tendaggi
small hooks



art. 93 a



art. 93 b



art. 93 c



art. 94 a/b/c/d/e



art. 95 a/b/c/d



art. 96



art. 97

Prezzi in € - Price in €

ART.	DESCRIZIONE	CONF. PEZZI	MISURE MM	OL	OBV	OCR
93 A-B-C	Gancetto bagno cucina <i>Small hook bathroom and kitchen</i>	100	A 46x38	1,54	1,81	1,99
		100	B 40x30	1,32	1,58	1,76
		100	C 34x22	1,18	1,45	1,62
94 A-B-C- D -E	Gancio fiorentino <i>Fiorentine small hook</i>	50	A 100x50x38	3,80	4,06	
		100	B 75x33x30	2,07	2,30	
		100	C 55x25x20	1,49	1,67	
		100	D 45x20x17	1,02	1,15	
		100	E 33x16x6	1,14	1,28	
95 A-B-C-D	Gancetto curvo c/vite <i>Small hook with screw</i>	100	A 40x15	1,98	2,29	2,46
		100	B 35x12	1,79	2,09	2,27
		100	C 30x11	1,35	1,54	1,62
		100	D 24x9	1,22	1,40	1,49
96 A-B-C	Gancetto per tendaggi c/vite <i>Small curtain hook with screw</i>	100	A 50x45	2,66	3,05	
		100	B 30x30	1,64	1,94	
		50	C 22x22	1,14	1,36	
97	Gancio doppio <i>Double small hook</i>	100	33x16x6	1,66	1,94	2,16



art. 199 a



art. 199 b



art. 199 c



art. 272 a



art. 272 b



art. 272 c



art. 275



art. 276



art. 277



art. 279

Prezzi in € - Price in €

ART.	DESCRIZIONE	CONF. PEZZI	MISURE MM	OL	OBV	OCR	OCS
199 A-B-C	Gancetto "elegant" c/vite <i>Small hook with screw</i>	100	A 40x30x16	1,68	1,80	1,94	2,46
		100	B 35x25x14	1,35	1,44	1,62	2,19
		100	C 25x20x12	1,12	1,25	1,39	1,96
272 A-B-C	Gancio pesante per tendaggi <i>Heavy small hook with screw</i>	50	A 50x44x25	3,64	3,85	4,12	4,68
		100	B 38x33x20	3,14	3,36	3,60	4,18
		100	C 33x26x15	2,66	2,88	3,15	3,68
275	Gancio pesante "swan" c/vite <i>Swan small hook with screw</i>	25	58x38x18	6,65	7,10	7,98	8,86
276	Gancio fiocchetto <i>Fiocchetto small hook</i>	50	25x35x10	1,95			
277	Gancio impero <i>Impero small hook</i>	25	49x43x10	8,45	8,88		
279	Gancio cherie <i>Cherie small hook</i>	100	38x12x7	2,25			



Prezzi in € - Price in €

ART.	DESCRIZIONE	CONF. PEZZI	MISURE MM	OL	OBV	OCR
405 A-B-C	Gancetto cuore <i>Heart small hook</i>	100	A 40x20x6	2,33	2,54	
		100	B 35x16x6	1,90	2,04	
		100	C 30x14x6	1,56	1,78	
406 A-B-C	Gancio rotondo <i>Round small hook</i>	100	A 32x20x6	1,85	1,99	
		100	B 29x16x6	1,58	1,75	
		100	C 26x14x6	1,25	1,41	
407 A-B	Gancio barocco <i>Baroque small hook</i>	100	A 34x20x7	1,58	1,72	
		100	B 16x15x5	1,29	1,55	
501	Gancetto quadrifoglio "grande" <i>Four-leaved big hook</i>	100	35x20x6	1,90	2,04	
502	Gancetto quadrifoglio "piccolo" <i>Four-leaved small size hook</i>	100	25x15x6	1,62	1,83	
503	Gancetto stella alpina "grande" <i>Edelweiss big size hook</i>	100	35x20x6	1,90	2,04	
504	Gancetto stella alpina "piccolo" <i>Edelweiss small size hook</i>	100	25x15x6	1,62	1,83	
505	Gancio tulipano grande <i>Tulip big size hook</i>	100	35x20x6	1,90	2,04	
506	Gancetto tulipano piccolo <i>Tulip small size hook</i>	100	25x15x6	1,62	1,83	
507	Gancetto goccia "grande" <i>Drop big size hook</i>	100	30x20x6	1,59	1,73	1,97
508	Gancetto goccia "piccolo" <i>Drop small size hook</i>	100	20x12x6	1,30	1,56	1,75



art. 515



art. 516



art. 517



art. 518



art. 522



art. 523



art. 524



art. 527



art. 528

Prezzi in € - Price in €

ART.	DESCRIZIONE	CONF. PEZZI	MISURE MM	OL	OBV	OCR
515	Gancetto quadrato "grande" <i>Square big hook</i>	100	32x16x 6	1,90	2,04	
516	Gancetto quadrato "piccolo" <i>Square small size hook</i>	100	26x13x 6	1,62	1,83	
517	Gancio triangolo grande <i>Triangle big size hook</i>	100	33x18x6	1,90	2,04	
518	Gancetto triangolo piccolo <i>Triangle small size hook</i>	100	26x14x6	1,62	1,83	
522	Gancetto edelweiss "grande" <i>Edelweiss big size hook</i>	100	35x27x6	2,06	2,22	2,59
523	Gancetto edelweiss "piccolo" <i>Edelweiss small size hook</i>	100	27x20x6	1,72	1,94	2,30
524	Gancetto fiocco <i>Flake small hook</i>	50	32x23x6	2,67	2,80	
527	Gancetto vanity "grande" <i>Vanity big size hook</i>	100	33x20x6	1,90	2,04	
528	Gancio vanity "piccolo" <i>Vanity small size hook</i>	100	29x17x6	1,62	1,83	



art. 408



art. 409



art. 410



art. 411



art. 419

Prezzi in € - Price in €

ART.	DESCRIZIONE	CONF. PEZZI	MISURE MM	OL	OBV	OCR	OCS	LNO
408	Gancio "liscio" con rosetta <i>Smooth hook with rosette</i>	25	45x90x65	8,20	9,40	9,96		
409	Gancio barocco c/rosetta <i>Baroque hook with rosette</i>	25	45x90x65	6,12	7,20	8,65		
410	Portabito "tipo Marina" <i>"Marina style hook for hanging clothes"</i>	25	80 x 80	3,68	4,20	4,65	6,80	
411	Portabito rustico in ferro <i>Rustic clothes stand made of black lacquered iron</i>	24	60x60					6,80
419	Portabito rustico in ferro <i>Rustic clothes stand made of black lacquered iron</i>	12	125x70					9,10



art. 520

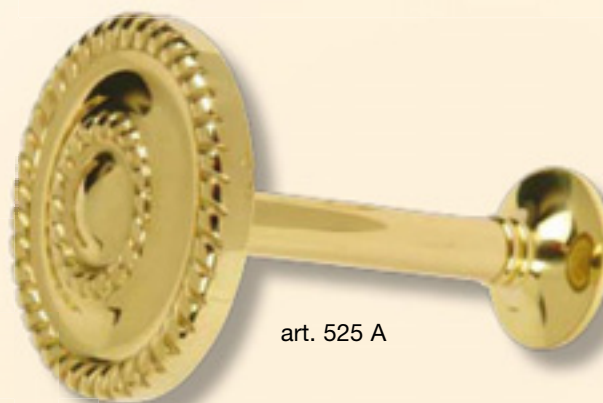

art. 525 A



art. 526 A



art. 529

Prezzi in € - Price in €

ART.	DESCRIZIONE	CONF. PEZZI	MISURE MM	OL	OBV	OCR	OLV
520	Embrasse "classic" <i>"Classic" Embrasse</i>	25	30	4,98			
		25	50	6,80			
		25	80	7,20			
		25	110	9,90			
		25	150	11,75			
		25	200	12,48			
525 A	Embrasse "Corona" <i>"Corona" Embrasse</i>	12	100 - Ø75				18,80
		12	150 - Ø75				19,60
		6	200 - Ø75				20,35
526 A	Embrasse "liscio" <i>"Victorian" embrasse</i>	12	100 - Ø75				18,80
		12	150 - Ø75				19,60
		6	200 - Ø75				20,35
529	Gancio liscio c/rosetta Ø40 <i>Plain hook with washer for drapery</i>	25	50x40x8	9,06	10,12	10,75	
		25	70x40x8	9,72	10,75	11,52	
		25	100x40x8	10,40	11,47	12,28	
		25	120x40x8	11,10	12,30	13,10	
		25	150x40x8	11,76	12,98	13,85	



art. 322



art. 323



art. 324



art. 333



art. 84

art. 86

Prezzi in € - Price in €

ART.	DESCRIZIONE	CONF. PEZZI	MISURE MM	OLV	OCR	OCS	FUMÈ
322	Gancio singolo "easy" c/rosetta Ø45 <i>Easy hook</i>	20	45x55x55	7,45	9,40	9,40	
323	Gancio doppio "easy" c/rosetta Ø45 <i>Easy double hook</i>	20	65x60x40	8,20	10,10	10,10	
324	Portabito "easy" c/rosetta Ø45 <i>"Easy" clothes hanger</i>	10	45x145x55	9,42	11,70	11,70	
333	Gancio appendi c/rosetta ottagonale <i>Hook with octagonal rosette</i>	20	40x68X42	4,80	6,78	6,78	
84	Portabito "Ambra" <i>"Ambra" clothes hanger</i>	4	Ø60	26,60		30,68	
86	Portabito "Export" <i>"Export" clothes hanger</i>	4	Ø60	22,48			23,98



art. 221



art. 222



art. 223



art. 224

Prezzi in € - Price in €

ART.	DESCRIZIONE	CONF. PEZZI	MISURE MM	Z/OTT	Z/BZ	Z/NIK	Z/CS
221	Portabito "Ronde" in zama "ROUNDE" zamak clothes hanger	12	145x108	19,35	20,60		
222	Portabito "Ark" in zama "ARK" zamak clothes hanger	12	125x108	19,35	20,60		
223	Portabito "Selene" in zama "SELENE" zamak clothes hanger	12	145x108	10,65	10,65	10,65	
224	Portabito "Classic" in zama "CLASSIC" Zamak clothes hanger	12	125x115	16,86	14,38		16,15

note





pomoli
door knobs



art. 1201



art. 1202



art. 1203



art. 1206



art. 1215



art. 1220

Prezzi in € - Price in €

ART.	DESCRIZIONE	CONF. PEZZI	MISURE MM	OLV	OBG	B/INV	OCS	BR.YEST	PVD	Z/CS
1201	Pomolo Selene con ros. quadra mm 50x50 <i>Selene knob with rose mm 50x50</i>	4	70x70	49,50		49,50	59,00	49,50		
1202	Pomolo Mirror c/ros. 50x50 <i>Mirror knob with rose mm 50x50</i>	4	60x60	37,00		37,00	49,50	37,00		
1203	Pomolo Square c. ros. mm 50x50 <i>Sirio Knob</i>	4	55x55							24,00
1206	Pomolo Sirio c. ros. mm 60 <small>Fis. con troncone passante</small> <i>Sirio Knob</i>	06	Ø60	27,60	27,60	27,60	38,90		71,20	
	Pomolo Sirio c. ros. mm 80 <small>Fis. con troncone passante</small> <i>Sirio Knob</i>	04	Ø70	33,80	33,80	33,80	46,00		79,00	
1215	Pomolo Medioevo c/ros. mm 80 <i>Medioevo knobs</i>	04	Ø90	61,00		61,00				
1220	Pomolo Corolla c. ros. Ø70 <small>Fissaggio con troncone passante</small> <i>Corolla Knobs</i>	04	Ø70	35,60	35,60		42,90			

Il fissaggio dei pomoli qui esposti, è possibile anche con piastrina art. PF01CF, vedi pag. 186, tenere conto dell'extra prezzo



art. 83



art. 1225



art. 1230



art. 1235



art. 1240

art. SF03
SET DI FISSAGGIO per art. 1240/1245

Prezzi in € - Price in €

ART.	DESCRIZIONE	CONF. PEZZI	MISURE MM	OLV	FUMÈ	OLS	OCS	OCR/OCS
83	Pomolo Export Fissaggio con troncone passante <i>Export Knob</i>	04	Ø60	15,00	16,00	15,00		
		04	Ø70	16,00	17,00	16,00	21,00	
	Pomolo Accoppiato	04	Ø60	29,00	30,00	29,00		
1225	Pomolo Grazia base da mm 85 Fissaggio con troncone passante <i>Grazia Knob</i>	04	Ø72	24,00				
1230	Pomolo Scarabeo Fissaggio con troncone passante <i>Scarabeo Knob</i>	04	Ø60	15,00	16,00			
		04	Ø70	16,00	17,00			
	Pomolo Accoppiato	04	Ø60	29,00	30,00			
1235	Pomolo Moresco Fissaggio con troncone passante <i>Moresco knob</i>	04	Ø60	15,00	16,00			
		04	Ø70	16,00	17,00			
	Pomolo Accoppiato	04	Ø60	29,00	30,00			
1240	Pomolo Minerva base 52 mm con accessori di fissaggio <i>Minerva pull door-knob Ø65 base 52 mm</i>	04	Ø65					32,80



art. 210



art. 82



art. 1215



art. 1220

Prezzi in € - Price in €

ART.	DESCRIZIONE	CONF. PEZZI	MISURE MM	OLV	FUMÈ	B/INV	OCS	PVD
83	Pomolo Sfera con rosetta mm 50 Fissaggio con troncone passante <i>Sphere Knobs with rosette mm 50</i>	04	Ø50	27,80	27,80	27,80	30,80	57,50
	Pomolo Sfera con rosetta mm 60 Fissaggio con troncone passante <i>Sphere Knobs with rosette mm 60</i>	04	Ø60	32,80	32,80	32,80	37,90	66,00
	Pomolo Sfera con rosetta mm 70 Fissaggio con troncone passante <i>Sphere Knobs with rosette mm 70</i>	04	Ø70	37,90	37,90	37,90	43,00	89,00
	Pomolo Sfera con rosetta mm 80 Fissaggio con troncone passante <i>Sphere Knobs with rosette mm 80</i>	02	Ø80	41,00	41,00	41,00	44,00	95,00
	Accoppiato Fissaggio con troncone passante <i>Double q.8</i>	03	Ø60	61,50	61,50	61,50	82,00	139,00
210	Pomolo Urano con rosetta mm 60 Fissaggio con troncone passante	06	Ø60	25,00	25,00	25,00	31,00	
	Pomolo Urano con rosetta mm 80 Fissaggio con troncone passante	04	Ø70	27,90	27,90	27,90	37,00	
	Accoppiato Fissaggio con troncone passante <i>Double q.8</i>	03	Ø60	55,00	55,00	55,00	67,90	
1215	Pomolo Diamante con ros. mm 60 Fissaggio con troncone passante	06	Ø60	25,80	25,80	25,80	33,90	
	Pomolo Diamante con ros. mm 70 Fissaggio con troncone passante	04	Ø70	30,80	30,80	30,80	43,00	
	Pomolo Diamante con ros. mm 80 Fissaggio con troncone passante	02	Ø80	36,90	36,90	36,90	49,00	
	Accoppiato Fissaggio con troncone passante <i>Double q.8</i>	03	Ø60	53,00	53,00	53,00	73,80	
1220	Pomolo Thema con ros. mm 60 Fissaggio con troncone passante	06	Ø60	25,00	25,00	25,00	31,00	
	Pomolo Thema con ros. mm 80 Fissaggio con troncone passante	04	Ø70	27,90	28,90	27,90	37,00	
	Accoppiato Fissaggio con troncone passante <i>Double q.8</i>	02	Ø60	55,00	55,00	55,00	67,90	

Il fissaggio dei pomoli qui esposti, è possibile anche con piastrina art. PF01CF, vedi pag. 186, tenere conto dell'extra prezzo.



art. 225



art. 230



art. 235



art. 240

Prezzi in € - Price in €

ART.	DESCRIZIONE	CONF. PEZZI	MISURE MM	OLV	FUMÈ	B/INV	OCS	PVD
225	Pomolo Ambra con ros. mm 60 Fissaggio con troncone passante	06	Ø60	25,00	25,00	25,00	31,00	
	Pomolo Ambra con ros. mm 70 Fissaggio con troncone passante	04	Ø70	27,90	30,90	27,90	37,00	
	Pomolo Ambra con ros mm 80 Fissaggio con troncone passante	02	Ø80	30,80	32,80	30,80	41,00	
	Accoppiato Fissaggio con troncone passante <i>Double q.8</i>	03	Ø60	55,00	55,00	55,00	62,00	
230	Pomolo Omega con ros. mm 60 Fissaggio con troncone passante	06	Ø60	27,80	27,80		36,90	
	Pomolo Omega con ros. mm 80 Fissaggio con troncone passante	04	Ø70	30,80	33,80		43,00	
	Accoppiato Fissaggio con troncone passante <i>Double q.8</i>	03	Ø60	61,50	63,50		71,80	
235	Pomolo Margherita con ros. mm 60 Fissaggio con troncone passante	06	Ø60	29,80	29,80	29,80	36,90	76,00
	Pomolo Margherita con ros. mm 70 Fissaggio con troncone passante	04	Ø70	33,80	33,80	33,80	43,00	88,00
	Pomolo Margherita con ros mm 80 Fissaggio con troncone passante	02	Ø80	44,00	44,00	44,00	55,00	90,00
	Accoppiato Fissaggio con troncone passante <i>Double q.8</i>	03	Ø60	57,00	57,00	57,00	73,80	146,00
240	Pomolo Delta con ros. mm 60 Fissaggio con troncone passante	06	Ø60	26,80	26,80	26,80	30,80	
	Pomolo Delta con ros. mm 80 Fissaggio con troncone passante	04	Ø70	28,80	28,80	28,80	36,90	
	Accoppiato Fissaggio con troncone passante <i>Double q.8</i>	02	Ø60	55,00	55,00	55,00	73,80	

Il fissaggio dei pomoli qui esposti, è possibile anche con piastrina art. PF01CF, vedi pag. 186, tenere conto dell'extra prezzo.

art. 246



SF03 KIT DI FISSAGGIO



art. 250



art. 251



Prezzi in € - Price in €

ART.	DESCRIZIONE	CONF. PEZZI	MISURE MM	OLV	FUMÈ	OBG	B/INV	OCS
246	Pomolo Marte Ø70 <i>Marte Knob Ø70</i>	04	Ø70	19,00				21,00
250	Pomolo Ambra con ros. mm 60 Fissaggio con troncone passante	06	Ø60	24,60	24,60		24,60	36,90
	Pomolo Ambra con ros. mm 70 Fissaggio con troncone passante	04	Ø70	27,80	27,80		27,80	43,00
	Accoppiato Fissaggio con troncone passante <i>Double q.8</i>	03	Ø60	55,00	55,00		55,00	73,80
251	Pomolo Zapping <i>Zapping Knob</i>	05	Ø70	24,00		25,50		29,80

Il fissaggio dei pomoli art.250 e 251, è possibile anche con piastrina art. PF01CF, vedi pag.???? tenere conto dell'extra prezzo.



complementi d'arredo
accessories

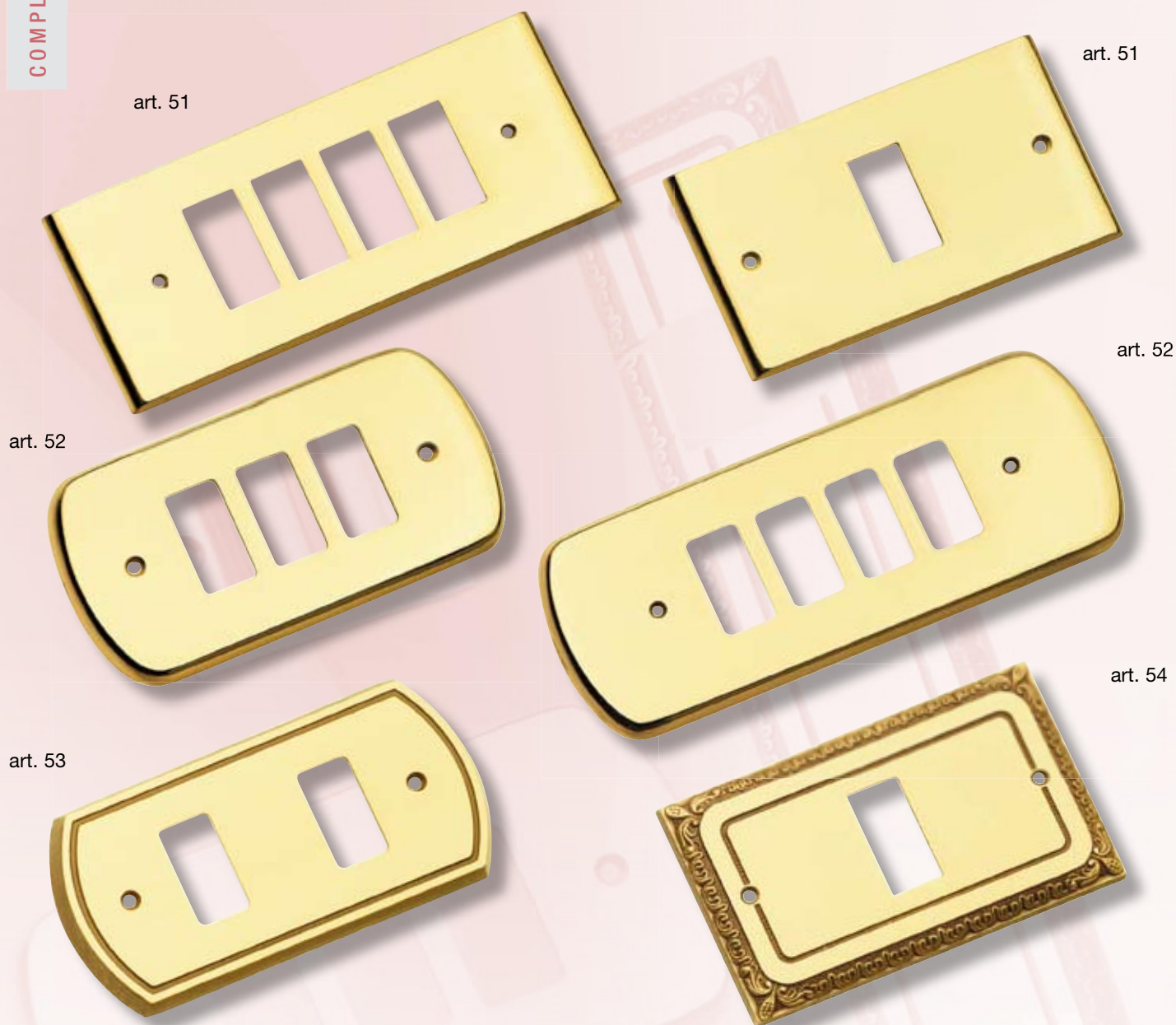

Prezzi in € - Price in €

ART.	DESCRIZIONE	CONF. PEZZI	MISURE MM	OLV	OBG	FUMÈ	OCS
51	Coprinterruttore Export cieco ticino magic <i>Export switch cover</i>	12	125x74	10,80	12,00		14,30
	Coprinterruttore Export 1-2-3 fori ticino magic <i>Export switch cover</i>	12		9,80	11,20		13,20
	Coprinterruttore Export 4-5 fori ticino magic <i>Azzurra switch cover</i>	12		18,00	18,95		21,50
52	Coprinterruttore Azzurra cieco ticino magic <i>Azzurra switch cover</i>	12		10,80	12,00		14,30
	Coprinterruttore Azzurra 1-2-3 fori ticino magic <i>Export switch cover</i>	12		9,80	11,20		13,20
	Coprinterruttore Azzurra 4-5 fori ticino magic <i>Azzurra switch cover</i>	12		18,00	18,95		21,50
53	Coprinterruttore Liscio 1/2/3 fori ticino magic <i>Liscio switch cover</i>	12				7,90	
54	Coprinterruttore Edera 1/2/3 fori ticino magic <i>Edera switch cover</i>	12				7,90	

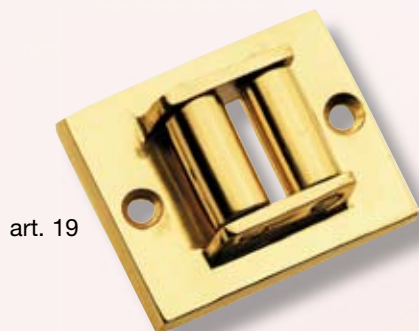

art. 19



art. 20



art. 22



art. 51/A



art. 52/A



art. 53/A



art. 54/A

Prezzi in € - Price in €

ART.	DESCRIZIONE	CONF. PEZZI	MISURE MM	OLV	OBG	FUMÈ	OCS	OCR	LB
19	Guidacinghia a rullo rettangolare <i>Rectangular belt guide roller</i>	24	60x45	10,50	10,50		11,00		10,50
20	Guidacinghia a rullo ovale orizzontale <i>Horizontal oval belt guide roller</i>	24	60x35	9,90	10,50		11,00	8,05	10,50
22	Guidacinghia a rullo ovale verticale <i>Vertical oval belt guide roller</i>	24	62x52	9,90	10,50		11,50		10,50
51A	Copriavvolgibile Export <i>Export roller blind plate</i>	16	240x55	12,80	13,90		16,50	16,50	13,90
52A	Copriavvolgibile Azzurra <i>Azzurra roller blind plate</i>	16	260x58	15,20	16,00		17,00	17,00	
53A	Copriavvolgibile Liscio <i>Liscio roller blind plate</i>	16				11,00			
54A	Copriavvolgibile Edera <i>Edera roller blind plate</i>	16				11,00			

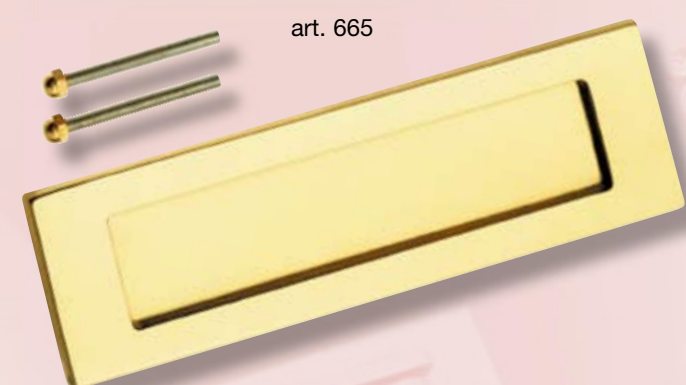

art. 665



art. 666



art. 667



art. 670



art. 669



art. 671

Prezzi in € - Price in €

ART.	DESCRIZIONE	CONF. PEZZI	MISURE MM	OLV	OBG	B/INV	OCS	OCR	NO/SAT
665	Buca per lettere con molla apertura interna <i>Letter box hole with spring</i>	01	254x75	40,80	46,50		52,80	52,80	
666	Buca per lettere a cadenza apertura esterna <i>Cadence letter box hole with</i>	01	254x75	37,50	43,50		49,50	49,50	
667	Buca per lettere "Blk" con molla apertura interna <i>Letter box hole with spring</i>	01	250x85	39,50					39,50
669	Buca per lettere "Maxi" a cadenza apertura esterna <i>Letter box</i>	01	300x130	153,00		153,00			
670	Placca portanome ovale leggera <i>Light oval nameplate plaque</i>	10	80x40	20,00					
		10	120x60	22,00					
671	Placca portanome ovale pesante <i>Heavy oval nameplate plaque</i>	01	140x70	64,00					



supporti
supports



art. 705



art. 706



art. 1120



art. 1121



art. 1125



art. 1130



art. 1131

Prezzi in € - Price in €

ART.	DESCRIZIONE	CONF. PEZZI	MISURE MM	OLV	OBG	OCS	OL/RAV
705	Pomolo caposcala liscio con gambo filettato <i>Smooth stair-head knob with threaded shank</i>	30	fil. mm 8 - Ø25				5,90
		30	fil. mm 8 - Ø30				9,80
		24	fil. mm 10 - Ø40				11,20
		6	fil. mm 10 - Ø50				15,80
		5	fil. mm 12 - Ø60				21,80
706	Pomolo caposcala zigrinato con gambo filettato <i>Stair-head knob with threaded shank</i>	30	fil. mm 8 - Ø25				4,00
		30	fil. mm 8 - Ø30				5,80
		24	fil. mm 10 - Ø35				6,10
		24	fil. mm 10 - Ø40				8,60
		6	fil. mm 10 - Ø50				11,00
		5	fil. mm 12 - Ø60				21,50
1120	Supporto liscio per tubo o corda <i>Smooth support</i>	6	Ø30	19,50	21,00	24,00	
		6	Ø35	21,80	23,50	25,50	
1121	Supporto liscio per tubo o corda <i>Smooth support</i>	6	Ø30	19,00	20,50	22,50	
		6	Ø35	21,00	22,50	24,00	
1125	Finale tondo per tubolare <i>Round finale</i>	6	Ø30	16,50	18,00	19,50	
		6	Ø35	18,00	19,50	21,00	
1130	Supporto sagomato tubo/corda <i>Support</i>	6	Ø30	22,50	24,00		
		6	Ø35	24,80	26,50		
1131	Supporto sagomato tubo/corda <i>Support</i>	6	Ø30	21,00	22,50		
		6	Ø35	21,50	25,00		



art. 30



art. 268



art. 270



art. 700



art. 701

Prezzi in € - Price in €

ART.	DESCRIZIONE	CONF. PEZZI	MISURE MM	OLV	OBV	OCS
30	Supporto per corrimano <i>Plain support for handrail</i>	12	85x60	9,00	9,80	10,50
268	Supporto per corrimano con appoggio concavo <i>Concave support for handrail</i>	12	53x65x66	9,20	9,20	10,50
270	Supporto per corrimano con appoggio piano <i>Plain support for handrail</i>	12	53x65x66	9,20	9,20	10,50
700	Supporto c/appoggio piano rosetta Ø50 <i>Concave support for handrail rosette Ø50</i>	12	90x60	15,20	15,20	17,80
701	Supporto con appoggio concavo e rosetta Ø70 <i>Concave support for handrail rosette Ø70</i>	12	90x60	15,20	15,20	17,80



art. 1300 A-B-C



Prezzi in € - Price in €

ART.	DESCRIZIONE	CONF. PEZZI	MISURE MM	F/LNO	F/SILVER	F/RAME	F/ORO
1300 A	Reggimensola in ferro battuto <i>Supporting console in iron</i>	8	280x220	18,50	19,30	18,50	18,50
1300 B	Reggimensola in ferro battuto <i>Supporting console in iron</i>	8	225x175	14,80	15,60	14,80	14,80
1300 C	Reggimensola in ferro battuto <i>Supporting console in iron</i>	8	155x125	11,00	11,80	11,00	11,00

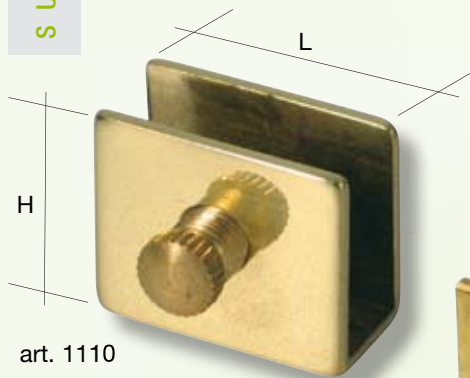

art. 1110

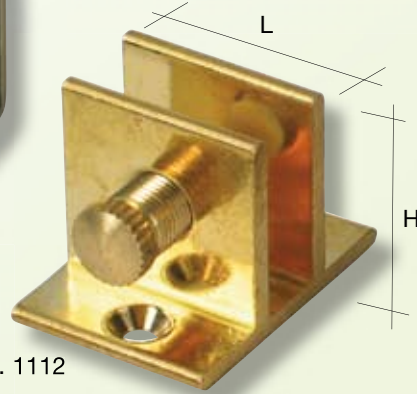

art. 1112

art. 1111

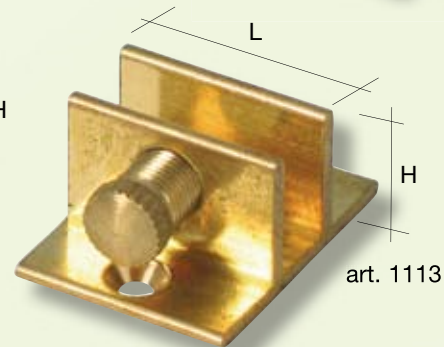
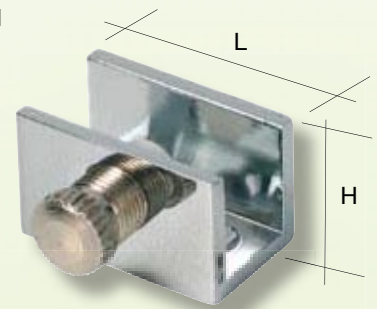

art. 1113

Prezzi in € - Price in €

ART.	DESCRIZIONE	CONF. PEZZI	MISURE MM		OL	OLV	OCR	OCS
			H	L				
1110	Reggimensola spessore max del vetro mm 10 <i>Clamped console inside max mm 10</i>	24	25	20	2,95	5,60	5,58	5,58
		24	25	25	3,14	5,76	5,76	5,76
		24	25	30	3,32	6,00	6,04	6,04
		24	25	35	3,50	6,33	6,32	6,32
		24	25	40	4,42	7,29	7,24	7,24
		24	25	50	5,16	8,06	7,97	7,97
		24	25	60	5,72	9,20	9,08	9,08
		24	25	80	6,46	9,98	9,82	9,82
		24	25	100	7,20	10,75	10,56	10,56
		24	25	120	7,94	11,50	11,30	11,30
1111	Reggimensola spessore max del vetro mm 10 <i>Clamped console inside max mm 10</i>	24	15	15	1,66	3,84	3,90	3,90
		24	15	20	1,88	4,07	4,14	4,14
		24	15	25	2,12	4,34	4,39	4,39
		24	15	30	2,32	4,72	4,76	4,76
		24	15	35	2,55	4,95	4,98	4,98
		24	15	40	2,77	5,18	5,20	5,20
1112	Reggimensola spessore max del vetro mm 8 <i>Clamped console inside max mm 8</i>	24	17	15	2,03	4,80	4,84	4,84
		24	17	20	2,22	4,99	5,02	5,02
		24	17	25	2,40	5,18	5,20	5,20
		24	17	30	2,68	5,47	5,48	5,48
		24	17	35	2,95	5,76	5,76	5,76
		24	17	40	3,23	6,05	6,04	6,04
1113	Reggimensola spessore max del vetro mm 8 <i>Clamped console inside max mm 8</i>	24	25	20	3,50	6,52	6,50	6,50
		24	25	25	3,69	6,72	6,68	6,68
		24	25	30	4,03	7,10	7,05	7,05
		24	25	35	4,43	7,67	7,60	7,60
		24	25	40	4,89	8,25	8,16	8,16
		24	25	50	5,54	9,20	9,08	9,08
		24	25	60	6,27	9,98	9,82	9,82
		24	25	80	6,83	10,75	10,55	10,55
		24	25	100	7,75	12,09	11,85	11,85
		24	25	120	8,86	13,24	12,95	12,95

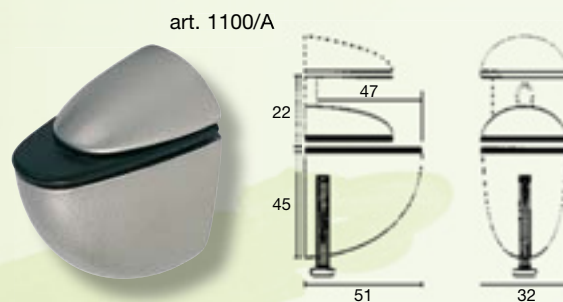
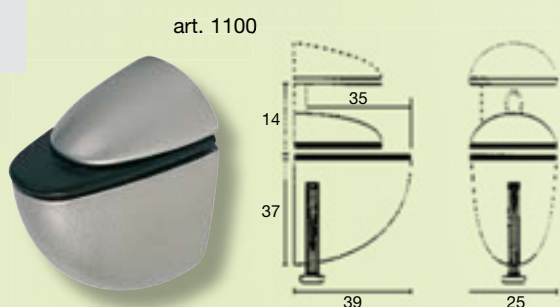

art. 2424



art. 1114



art. 1115



art. 2425

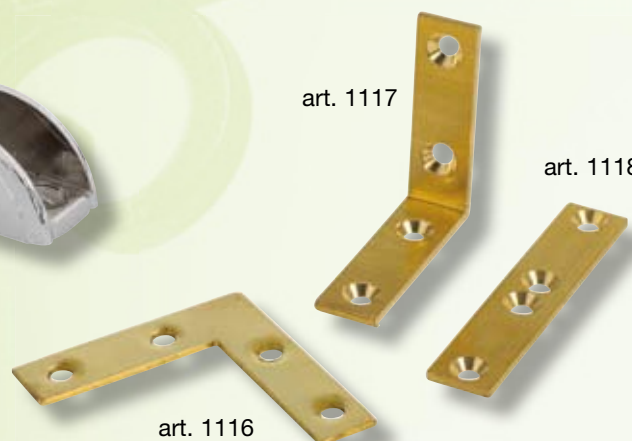

art. 1117

art. 1118

art. 1116

Prezzi in € - Price in €

ART.	DESCRIZIONE	CONF. PEZZI	MISURE MM	Z/CR	Z/CRS	OLV	OCR	OCS	OL
1100	Reggimensola super clip spessore max del vetro mm 14 <i>Clamped console inside max mm 14</i>	10	37x39x25	5,00	5,50				
1100 A	Reggimensola super clip spessore max del vetro mm 22 <i>Clamped console inside max mm 22</i>	12	45x51x32	6,50	6,50				
1114	Reggimensola 38x18 spessore max del vetro mm 8 <i>Clamped console inside max mm 8</i>	20	38X18			3,95	4,90	4,90	
1115	Reggimensola 38x18 spessore max del vetro mm 12 <i>Clamped console inside max mm 12</i>		38X18			3,95	4,90	4,90	
1116	Angolare piano in ottone <i>Flate angular frame</i>	125	30x30 45x45 60x60						2,40 2,70 3,90
1116	Angolare piano in ottone <i>Flate angular frame</i>	125	30x30 45x45 60x60						2,40 2,70 3,90
1117	Angolare reggi piano in ottone <i>Supporting flat angular frame</i>	100	30x30 40x40 50x50						1,55 1,76 2,24
118	Asta piana svasata <i>Flat flared shaft</i>	100	60 80 100 120 140 160						1,42 1,75 1,98 2,22 4,06 4,48
2424	Reggimensola per vetrine Ø20 spessore max del vetro mm 8 <i>Clamped console inside max mm 8</i>	25				6,25	7,30	7,30	
2425	Mensola reggispecchio Ø25 <i>Clamped console Ø25</i>	25				8,80	10,00	10,00	



catenacci
bolts

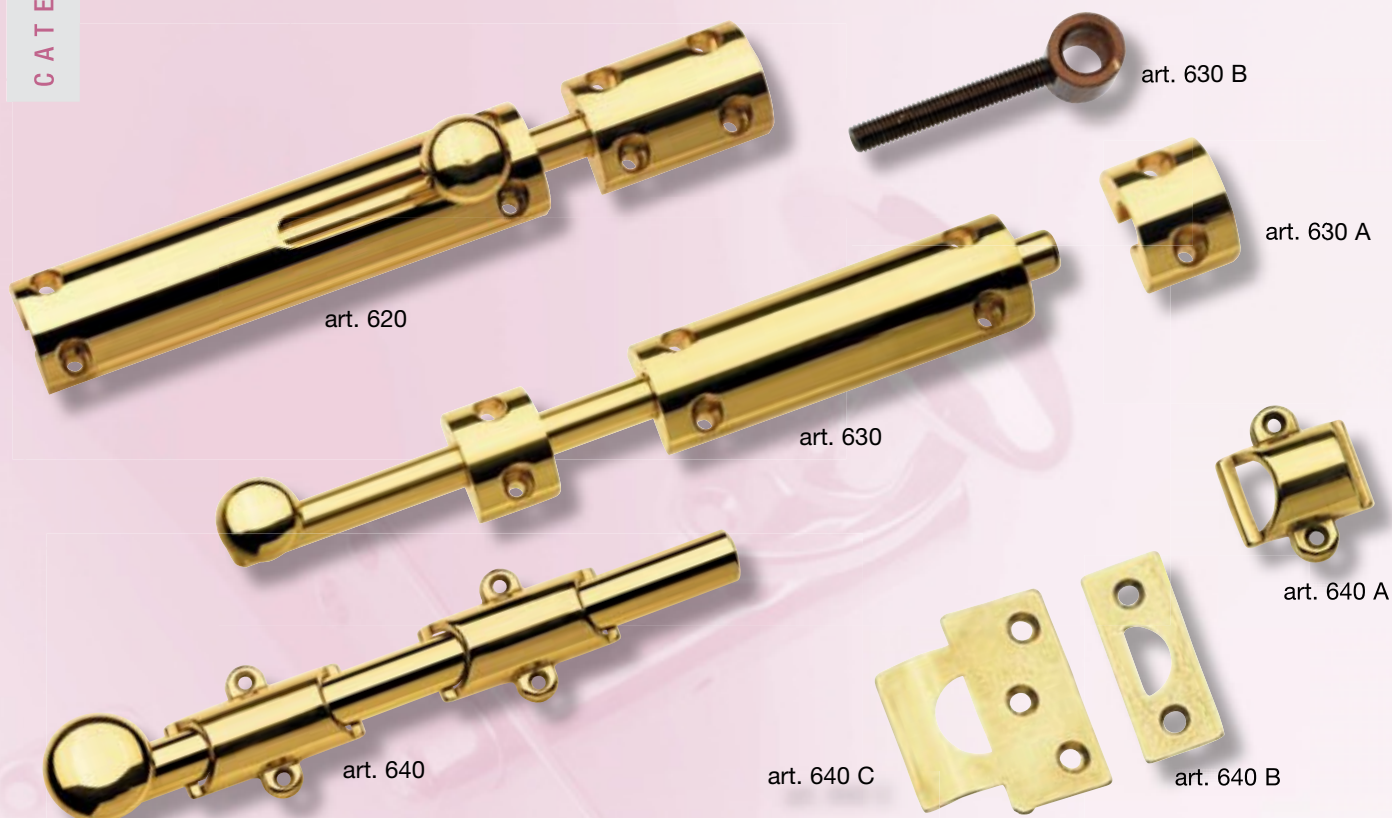

Prezzi in € - Price in €

ART.	DESCRIZIONE	CONF. PEZZI	MISURE MM	OLV	OBV	OCR	OCS	
620	Catenaccio orizzontale tondo base mm 33 corsoio Ø13 mm <i>Horizontal round bolt base mm 33 slider Ø13 mm</i>	06	100	36,20	37,70	46,50	48,00	
		06	120	36,20	37,70	46,50	48,00	
		06	150	43,50	45,00	53,60	55,00	
		06	200	50,70	52,00	62,50	63,80	
		06	250	58,00	59,50	71,00	72,50	
		06	300	68,00	69,50	81,00	82,60	
		06	400	78,20	79,70	91,30	92,80	
630	Catenaccio verticale tondo base mm 33 corsoio Ø13 mm - senza incontro <i>Vertical round bolt base mm 33 slider Ø13 mm - without matching plate</i>	06	200	39,00	39,90	50,80	52,00	
		06	250	44,90	46,40	53,60	55,80	
		06	300	50,80	52,20	60,90	62,30	
		06	400	63,80	65,20	75,40	76,80	
		06	500	76,80	78,20	88,40	89,90	
		06	600	89,90	91,30	101,40	102,90	
		06		7,50	7,95	9,80	9,80	
	incontro "A" Matching plate A							
	incontro "B" Matching plate B							
640	Catenaccio americano senza incontro <i>American round bolt base mm 33 slider Ø13 mm - without matching plate</i>	06	80	25,60				
		06	100	26,80				
		06	120	28,20				
		06	150	35,70				
		06	200	39,30				
		01	250	40,00				
		01	300	41,70				
		01	350	49,60				
		01	400	58,50				
		01	450	61,50				
		01	600	63,50				
		06		5,30				
		06		1,80				
06		1,80						
640 A	incontro "A" Matching plate A							
640 B	incontro "B" Matching plate B							
640 C	incontro "C" Matching plate C							

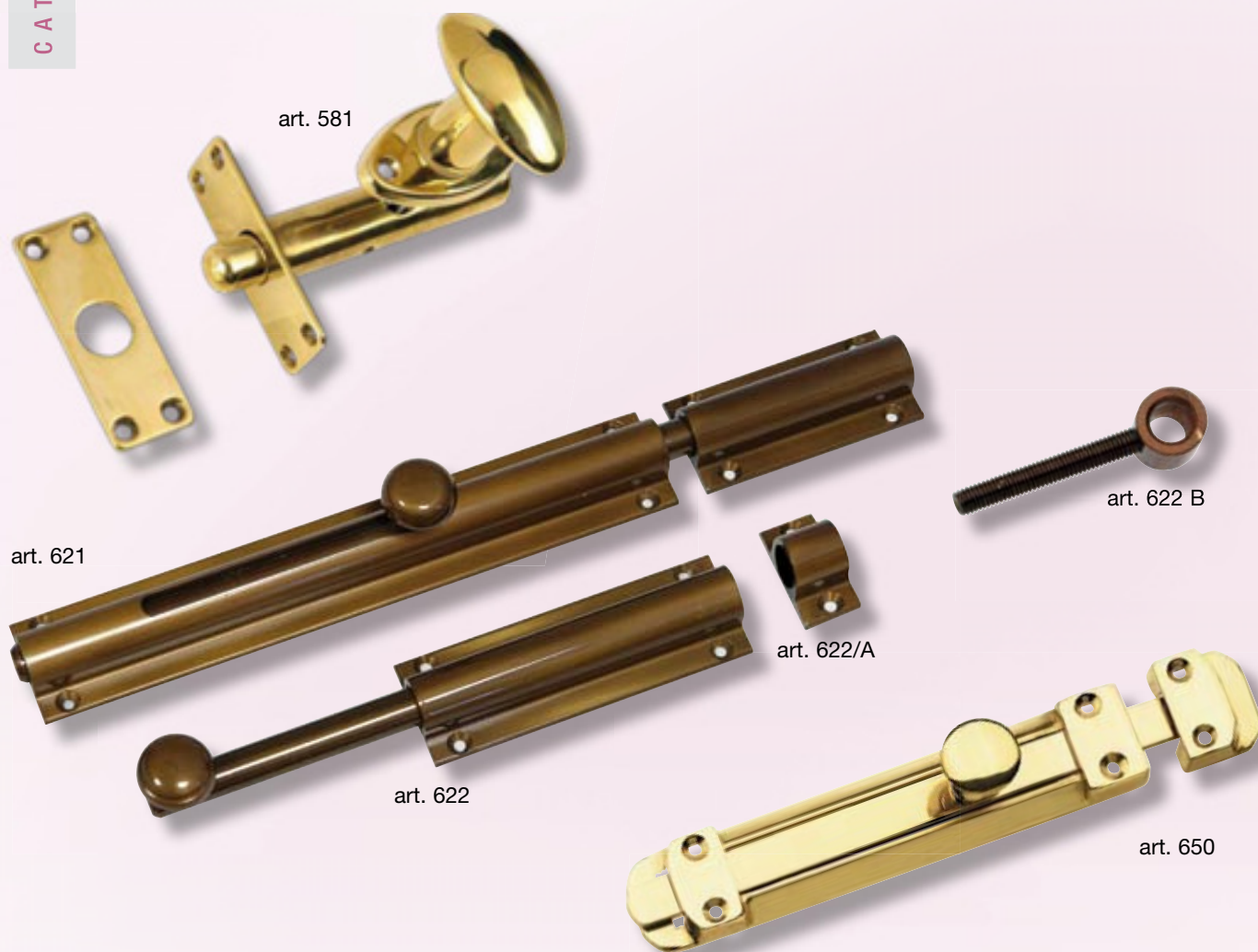

Prezzi in € - Price in €

ART.	DESCRIZIONE	CONF. PEZZI	MISURE MM	OLV	OBV	OCR	OCS	OL	OBR
581	Segretino con catenaccio a cremagliera <i>Secret lock with rack-bolt</i>	06	60				30,40	23,90	26,00
		06	80				30,40	23,90	26,00
621	Catenaccio orizzontale tondo base mm 38 corsoio Ø13 mm <i>Horizontal round bolt base mm 38 slider Ø13 mm</i>	06	100	36,50	37,70	46,40	47,80		
		06	120	36,50	37,70	46,40	47,80		
		06	150	43,50	44,90	53,60	55,00		
		06	200	50,70	52,20	62,30	63,80		
		06	250	58,00	59,40	71,00	72,50		
		06	300	68,10	69,50	81,00	82,60		
		06	400	78,20	79,70	91,30	92,70		
622	Catenaccio Verticale tondo base mm 38 corsoio Ø13 mm <i>Vertical round bolt base mm 38 slider Ø13 mm</i>	06	200	39,20	39,90	50,70	52,20		
		06	250	44,90	46,40	53,60	55,80		
		06	300	50,70	52,20	60,90	62,30		
		06	400	63,80	65,20	75,30	76,80		
		06	500	76,80	78,25	88,40	89,90		
		06	600	89,90	91,30	101,40	102,9		
		06			7,30	7,70	9,50	9,50	
	incontro "A" Matching plate A								
	incontro "B" Matching plate B								
650	Catenaccio tradizionale con incontro <i>Traditional bolt with matching plate</i>	12	120	13,90					
		12	150	16,30					
		12	200	18,40					
		12	250	23,40					
		12	300	30,00					



art. 287

art. 288

art. 289

Prezzi in € - Price in €

ART.	DESCRIZIONE	CONF. PEZZI	MISURE MM	OLV	OL	OBR
287	Catenaccio tondo con molla base mm 31 senza incontro <i>Round bolt with base spring 31 mm - without matching plate</i>	12	60		5,00	5,50
		12	80		5,80	6,30
		12	100		6,60	7,20
		12	120		7,40	8,20
		12	150		8,60	9,30
		12	200		10,90	11,80
		12	250		13,00	14,00
		12	300		15,30	16,10
		12	400		19,60	20,50
			Incontro a richiesta	12		
288	Catenaccio cannone base mm 31 senza incontro <i>Vertical round bolt - without matching plate</i>	12	60		5,20	5,80
		12	80		6,00	6,60
		12	100		6,80	7,40
		12	120		7,80	8,55
		12	150		9,00	9,80
		12	200	14,70	11,55	12,15
		12	250	16,70	13,90	14,90
		12	300	18,40	15,80	16,45
		12	400	23,00	20,40	21,20
		12	500	27,60	25,00	25,70
	Incontro a richiesta	12		1,20	1,04	1,12
289	Catenaccio tondo a coda base mm 31 senza incontro <i>Round bolt - without matching plate</i>	12	200		10,00	10,50
		12	250		11,30	11,80
		12	300		12,60	13,50
		12	400		16,60	17,40
		12	500		19,50	20,45
			Incontro a richiesta <i>Matching plate on request</i>	12		



Prezzi in € - Price in €

ART.	DESCRIZIONE	CONF. PEZZI	MISURE MM	OL	OBV		
31	Catenaccio orizzontale pesante base mm 45 corsoio mm 20x5 <i>Horizontal heavy bolt base mm 45 slider mm 20x5</i>	06	150	31,00	32,50		
		06	200	32,50	34,00		
		06	250	34,00	35,50		
		06	300	39,90	41,40		
		06	350	45,80	47,00		
		06	400	50,00	51,70		
31 B	Catenaccio verticale pesante base mm 45 corsoio mm 20x5 senza incontro <i>Vertical heavy bolt base mm 45 slider mm 20x5</i>	06	200	32,50	34,00		
		06	250	34,00	35,50		
		06	300	39,90	41,40		
		06	350	45,80	47,00		
		06	400	50,00	51,70		
		06	500	59,40	60,80		
		06	600	69,50	71,00		
			incontro a richiesta mm 20 <i>Matching plate on request</i>	06	20	2,95	3,10
			incontro a richiesta mm 70 <i>Matching plate on request</i>	06	50	6,65	7,10
		31 M	Catenaccio orizzontale medio, base mm 38 completo di incontro corsoio mm 15x4,5 <i>Horizontal middle bolt base mm 38 slider mm 15x4,5</i>	12	80	11,25	11,85
12	100			12,75	13,35		
12	130			14,70	15,30		
12	150			16,50	17,98		
12	200			18,75	20,25		
12	250			21,75	23,25		
12	300			24,75	25,50		
31 BM	Catenaccio verticale medio base mm 38 senza incontro corsoio mm 15x4,5 <i>Vertical middle bolt base mm 38 slider mm 15x4,5</i>			12	150	16,50	17,98
		12	200	18,75	20,25		
		12	250	21,75	23,25		
		12	300	24,75	25,50		
		12	400	27,35	28,10		
		12	500	30,30	31,00		
		12	600	34,00	35,50		
			incontro a richiesta mm 15 <i>Matching plate on request</i>	12		2,25	2,70
			incontro a richiesta mm 30 <i>Matching plate on request</i>	12		3,75	4,20

art. 16



art. 17

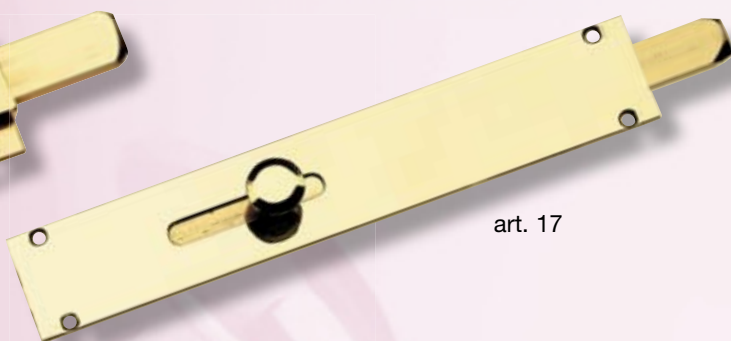

art. 31 CM



art. 31 DM



Prezzi in € - Price in €

ART.	DESCRIZIONE	CONF. PEZZI	MISURE MM	OL	OBR		
16	Catenaccio a coda medio base mm 38 corsoio mm 15x4,5 <i>Vertical middle bolt base mm 38 slider mm 15x4,5</i>	12	200	12,80	13,50		
		12	250	14,55	16,00		
		12	300	16,40	18,00		
		12	400	19,60	21,00		
		12	500	22,80	24,00		
		12	600	25,50	27,00		
			incontro mm 15 a richiesta	12		2,25	2,70
17	Catenaccio verticale sottolastra base mm 38 corsoio mm 15x4,5 senza incontro <i>Vertical bolt base mm 38 slider mm 15 x4,5</i>	12	100	12,75	13,35		
		12	150	14,70	17,98		
		12	200	18,70	20,20		
		12	250	21,70	23,20		
		12	300	24,70	25,50		
		12	400	27,70	28,50		
		12	500	30,70	31,50		
		12	600	34,50	36,00		
			incontro mm 30 a richiesta <i>Matching plate on request</i>	12		3,75	4,20
		31 CM	Catenaccio verticale medio terminale tondo mm 10 base mm 38 corsoio mm 15x4,5 <i>Vertical middle bolt base mm 38 slider mm 15x4,5</i>	12	150	22,50	23,98
12	200			24,70	26,20		
12	250			27,70	29,20		
12	300			30,70	31,50		
12	400			33,70	34,50		
12	500			36,70	37,50		
12	600			40,50	41,90		
31 DM	Catenaccio verticale a ginocchio base mm 38 corsoio mm 15x4,5 senza incontro <i>Vertical middle bolt base mm 38 slider mm 15x4,5</i>			12	200	24,70	26,20
		12	250	27,70	29,20		
		12	300	30,70	31,50		
		12	400	33,70	34,50		
		12	500	36,70	37,50		
		12	600	40,50	41,90		

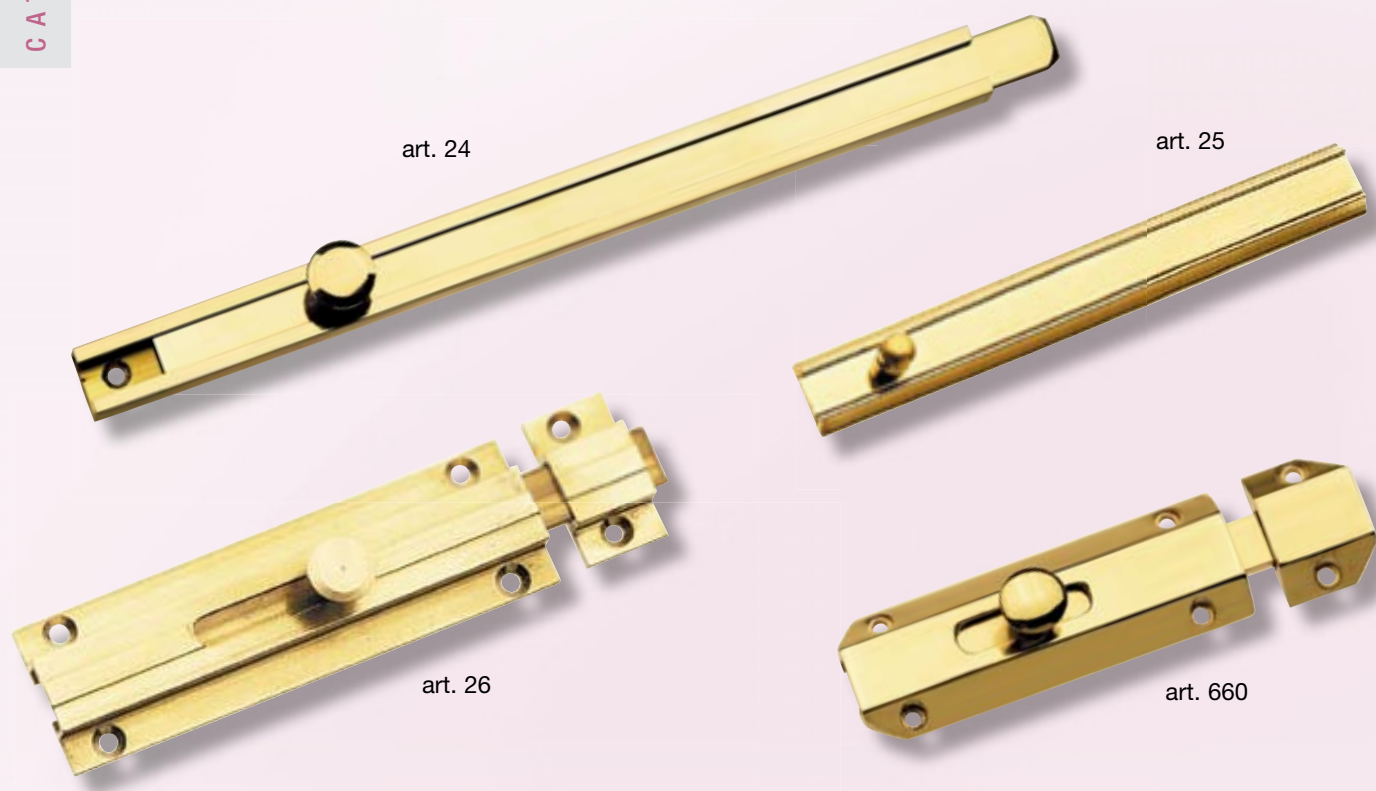

Prezzi in € - Price in €

ART.	DESCRIZIONE	CONF. PEZZI	MISURE MM	OL	OBR	OLV
24	Catenaccio binario grande base mm 20 corsoio mm 15x3 senza incontro <i>Bolt large track base 20 mm - without matching plate</i>	12	100	12,70	13,30	
		12	130	13,90	16,50	
		12	150	14,70	17,95	
		12	200	18,70	20,20	
		12	250	21,70	23,20	
		12	300	24,70	25,50	
		12	400	27,70	28,50	
		12	500	30,70	31,50	
		12	600	34,50	35,90	
			Incontro a richiesta <i>Matching plate on request</i>			3,75
25	Catenaccio binario <i>Track bolt</i>	50	50	1,76	2,06	
		50	60	1,79	2,16	
		50	70	1,94	2,37	
		50	80	2,16	2,60	
		50	90	2,37	2,80	
		50	100	2,60	3,10	
		50	120	3,04	3,38	
		50	150	3,50	3,70	
26	Catenaccio sagomato base mm 31 <i>Bolt base 31 mm</i>	25	50	3,28	3,72	
		25	60	3,44	3,88	
		25	80	3,72	4,15	
		25	100	4,12	4,48	
		25	120	6,30	6,82	
		25	140	6,82	7,44	
		25	160	7,39	7,96	
		25	180	7,96	8,58	
660	Catenaccio sfaccettato con incontro <i>Facet bolt with matching plate</i>	12	50			9,20
		12	75			13,88
		12	100			18,40
		12	125			22,56

note





accessori vari
accessories

art. 21



art. 23



art. 92



art. 98



Prezzi in € - Price in €

ART.	DESCRIZIONE	CONF. PEZZI	MISURE MM	OL	OBR	OCR	OCS	B/INV		
21	Tavellino alla "romana" con incontro <i>Roman style latch "with contact"</i>	50	15	2,95	3,30	3,70				
		50	20	3,05	3,40	3,70				
		50	25	3,30	3,75	4,00				
23	Tavellino alla romana tipo "pesante" con incontro <i>Roman style latch "heavy type" with contact</i>	25		5,60	5,99	6,85	7,70			
		25		5,60	5,99	6,85	7,70			
		25		5,60	5,99	6,85	7,70			
		25		5,60	5,99	6,85	7,70			
		25		5,60	5,99	6,85	7,70			
		25		5,60	5,99	6,85	7,70			
		25		5,60	5,99	6,85	7,70			
		25		5,60	5,99	6,85	7,70			
92	Tavellino a scatto "liscio" senza incontro <i>Small push-fit table "without contact"</i> Solo incontro per tavellino a scatto <i>Contact only</i>	50		2,99	3,29	3,48	4,78	4,78		
		50	5	1,10	1,30	1,60	2,50	1,95		
		50	10	1,10	1,30	1,60	2,50	1,95		
		50	15	1,18	1,36	1,66	2,50	2,05		
		50	20	1,18	1,36	1,66	2,50	2,05		
		50	25	1,39	1,49	1,72	2,50	2,15		
		50	30	1,39	1,49	1,72	2,50	2,15		
		50		2,99	3,29	3,48				
		98	Tavellino a scatto "barocco" "senza incontro" <i>Small push-fit table "without contact"</i> Solo incontro per tavellino a scatto <i>Contact only</i>	50		2,99	3,29	3,48		
				50	5	1,10	1,30	1,60		
50	15			1,18	1,36	1,66				
50	25			1,39	1,49	1,72				



art. 261
MANO SINISTRA



art. 532



art. 126



art. 533

Prezzi in € - Price in €

ART.	DESCRIZIONE	CONF. PEZZI	MISURE MM	OL	OBR	OCR	OCS
261	Tavellino circolare c/incontro dx e sx <i>Latch with matching plate right and left</i>	25		8,25	8,70	9,98	11,70
532	Tavellino con incontro regolabile <i>Latch with matching plate</i>	25	41x18x22	7,85	8,45	8,88	
533	Tavellino a scatto liscio pesante "senza incontro" <i>Push fit tile smooth heavy type w/out contact</i>	30	62x27	8,32	9,06	9,70	
	Incontro tavellino liscio pesante <i>Contact for smooth heavy type tile</i>	30	5	2,03	2,38		2,60
		30	15	2,33	2,59		2,85
		30	20	2,38	2,65		2,92
		30	25	2,46	2,80		3,00
		30	30	2,54	2,86		3,08
126	Gancio di sicurezza tipo "roma" c/inc. <i>Safety hook "ROMA" type with matching plate</i>	12	130x65	7,90	8,30	9,65	11,20



art. 32



art. 297



art. 298



art. 299



art. 300

Prezzi in € - Price in €

ART.	DESCRIZIONE	CONF. PEZZI	MISURE MM	OL	OBR	OCR	OLV
32	Catenella barocco c/incontro filo <i>Baroque chain thread Ø2 mm</i>	25	190	4,40	4,80		
297	Catena di sicurezza c/inc. filo Ø2,5 mm <i>Safety chain with matching plate thread Ø2,5 mm</i>	20	220		10,20		10,20
298	Catenella liscia leggera c/incontro filo Ø2 <i>Safety chain with matching plate thread Ø2,5 mm</i>	50	150	3,60	4,26	5,15	
299	Catenella liscia pesante c/incontro filo Ø2 <i>Safety chain heavy with matching plate thread Ø2</i>	50	180	4,25	4,50	5,80	
300	Catena liscia pesante c/incontro filo Ø2,5 <i>Safety chain heavy type with matching plate thread Ø2,5 mm</i>	20	240	9,40	10,40	11,96	



Prezzi in € - Price in €

ART.	DESCRIZIONE	CONF. PEZZI	MISURE MM	OL	OBR	OCR	OCS	OLV	OBG
27	Cricchetto sopraluce c/inc. A - B - C <i>Over door ratchet with matching A - B - C</i>	50	A - B	4,08	4,68	5,30	7,80		
		50	C	6,02	6,72	7,35	11,00		
29	Pinza fermaporta c/incontro A: a piolo <i>Door stop catch with matching plate A: to peg</i>	50		3,80	4,28	4,90	7,30		
	Pinza fermaporta c/incontro B: a legno <i>Door stop catch with matching plate B: to wood</i>	50		3,80	4,28	4,90	7,30		
254	Guida vasistas con incontro <i>Vasistas guide with matching plate</i>		200x25x35						
271	Fermaporta a chiocciola <i>Door stopper</i>	30				4,70	4,40	4,70	
273	Fermaporta cilindrico <i>Door stopper</i>	20	Ø25 x h25			7,29	7,29	6,55	7,35
		20	Ø28 x h45			8,95	8,95	8,25	8,80
274	Fermaporta k2 <i>K2 door stopper</i>	12	50x30			11,20	10,40	8,90	10,40
275	Fermaporta elegant <i>Elegant door stopper</i>	12	60x25x16			9,75	8,90	7,50	8,90

art. 81



art. 85



art. 127



art. 257



art. 258



art. 418



art. 422



art. 423



art. 424



Prezzi in € - Price in €

ART.	DESCRIZIONE	CONF. PEZZI	MISURE MM	OL	OBR	OCR	OCS	B/INV	OLV	OBV
81	Chiodo piramidale con vite staccata <i>Nail for door with screw</i>	50	20x20					2,65	2,28	
		50	25x25					4,16	3,60	
		50	30x30					4,95	4,40	
85	Chiodo piramidale per portoni <i>Nail for door</i>	50	20x20	3,48	4,10					
127	Gancio fermapersiane c/incontro <i>Blind fastening hook</i>	50	60	4,70	5,05	6,25	6,85			
		50	80	5,05	5,30	6,52	7,20			
		50	100	5,42	5,75	6,80	7,60			
		25	120	5,90	6,20	7,20	8,40			
		25	140	6,25	6,50	7,50	8,70			
		25	160	9,75	10,50	10,90				
		25	180	10,50	11,15	11,50				
		25	200	11,15	11,90	12,40				
		25	250	12,50	13,25	13,80				
25	300	13,90	14,80	15,30						
257	Omino fermapersiane con vite e fermo <i>Blind-stay hanger with stop and screw</i>	20		9,50	10,60					
258	Omino fermapersiane con zanca e fermo <i>Blind-stay hanger with stop and clamped</i>	20		9,50	10,60					
418	Fermaporta a muro <i>Wall door stopper</i>	6	75x39x27			17,20	17,20		16,00	16,00
422	Fermaporta magnetico <i>Magnetic door stopper</i>	6	46x30x28			30,20	32,50		26,22	26,77
423	Fermaporta sferico <i>Sphere door stopper</i>	24	Ø25x25			5,98	5,98	6,85	5,18	5,98
424	Fermaporta sagomato <i>Door stopper</i>	24	Ø25x25			5,98	5,98		5,18	5,98

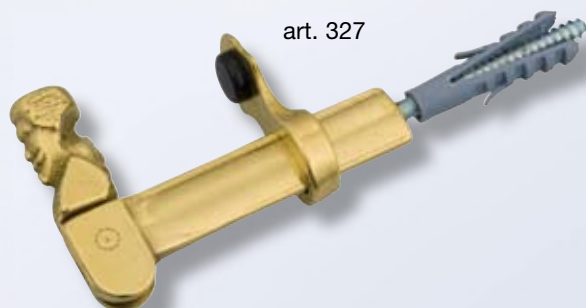

art. 327



art. 328



art. 329



art. 259



art. 260

Prezzi in € - Price in €

ART.	DESCRIZIONE	CONF. PEZZI	MISURE MM	OL	OBR	LNO
327	Omino ferma persiane c/fermo regolabile fissaggio a vite <i>Blind-stay hanger with stop and screw</i>	20	95x68	15,01	16,25	17,34
328	Fermapersiane "goccia" c/fermo fissaggio a vite <i>Blind-stay hanger with stop and screw</i>	20	95x65	11,78	12,95	
329	Fermapersiane "goccia" c/fermo regolabile fissaggio a vite <i>Blind-stay hanger with stop and screw</i>	20	95x65	15,30	16,54	
259	Fermapersiane con ribaltino fissaggio a vite <i>Blind-stay with screw</i>	12		10,70	11,85	
260	Fermapersiane con ribaltino fissaggio a muro <i>Blind-stay with clamped</i>	12		10,70	11,85	



art. 331



art. 332

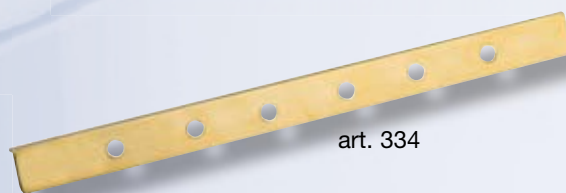

art. 334



art. 336



art. 530

Prezzi in € - Price in €

ART.	DESCRIZIONE	CONF. PEZZI	MISURE MM	OL	OBR	OCR	B/INV	LNO
331	Fermapersiane con gancio scorrevole e incontro <i>Shutter catch with rod and sliding hook</i>	30	85x25	12,00	12,85		14,45	13,50
332	Fermapersiane con gancio a molla inox e incontro <i>Shutter catch with rod and stainless spring hook</i>	30	70x25	11,70	12,55		14,00	13,15
334	Incontro a cremagliera per ganci fermapersiane <i>Rack adjusting-rod</i>	25	250x20x15	11,26	12,07	13,29		
336.20	Gancio fermapersiane reregolabile alla triestina Ø8 mm	10	200/250	24,02	24,94			25,74
336.25	<i>Adjustable triestine type blind retainer hook</i>	10	250/300	24,32	25,21			26,03
336.30		10	300/350	24,78	25,67			26,52
336.35		10	350/400	25,67	26,54			27,13
336.40		10	400/450	26,24	26,84			27,57
336.45		10	450/500	27,14	27,43			28,14
530	Spagnoletta con rosetta e incontri da 5-25-30 mm	24	L 60	12,00	13,00			
	<i>Spagnoletta with washer and contact 5-25-30 mm</i>	24	L 80	12,90	13,80			



art. 680



art. 681



art. 682



art. 683



art. 684



art. 688



art. 679

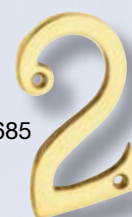

art. 685



art. 686



art. 687



art. 689

Prezzi in € - Price in €

ART.	DESCRIZIONE	CONF. PEZZI	MISURE MM	OLV	FUMÈ	OCR	OCS	B/INV	BR.YEST
680	Simboli wc omino e donnina (coppia) <i>Pair of man/woman wc symbols</i>	12	30x100 h	12,30	14,36	18,45	18,45	14,36	14,36
681	Simboli wc scarpetta e pipa (coppia) <i>Pair of small shoe / pipe wc symbol</i>	12	100 x 50 h	12,30	14,36	18,45	18,45	14,36	14,36
682	Scritta "wc" <i>Wc writing</i>	12	100 x 50 h	6,20	7,20	8,25	8,25	7,20	7,20
683	Scritta toilette <i>Toilette writing</i>	12	130 x 40 h	6,20	7,20	8,25	8,25	7,20	7,20
684	Bambino disabile <i>Handicapped wc</i>	12	60 x 85 h	8,85	10,25	12,30	12,30	10,25	10,25
688	Divieto di fumo <i>No smoking</i>	12	100	11,10	12,90	16,60	16,60		12,90
679	Numeri civici fissaggio c/viti 5 ma e tasselli <i>Civic number with screw</i>	10	100	7,20					
685	Numeri civici fissaggio c/viti <i>Civic number</i>	10	75	5,60					
		10	125	7,40					
686	Numero civico gotico fissaggio c/viti e tasselli <i>Gothic civic number</i>	10	120		8,70				
687	Lettere dalla "A" alla "Z" fissaggio con pioli <i>Letter 50 mm</i>	10	50	4,26					
689	Numeri civici da 50 mm fissaggio con pioli <i>Civic number 50 mm</i>	10	50	4,26					



art. 18



art. 495



art. 1150



art. 1165



art. 1166

Prezzi in € - Price in €

ART.	DESCRIZIONE	CONF. PEZZI	MISURE MM	OL	OBR	OCR
18	Cavallotti a rullo <i>Roller holders</i>	50	11	1,45	1,65	1,95
		50	15	1,45	1,65	1,95
		50	18	1,45	1,65	1,95
		50	20	1,65	1,85	2,28
		50	25	1,70	1,90	2,35
		50	30	1,75	1,95	2,40
		50	30	1,75	1,95	2,40
1150/6	Pozzetto antipolvere con molla	50	Ø6	1,70		
1150/8	<i>Trap with spring and precision stopper</i>	50	Ø8	1,95		
1150/10		50	Ø10	2,25		
1150/12		50	Ø12	2,60		
1150/14		50	Ø14	2,90		
1150/16		50	Ø16	4,10		
1150/18		50	Ø18	4,35		
1150/20		50	Ø20	4,35		
1150/22		50	Ø22	4,75		
1165	Cavallotto a rullo con vite a legno 20 mm <i>U-bolt with wood screw 20 mm</i>	50	20	2,30	2,68	3,00
1166/25	Cavallotto a fuga	50	25	2,25	2,50	2,89
1166/30	<i>Flight u-bolt</i>	50	30	2,35	2,65	3,00
495	Passante o finale per cremonesi con aste esterne <i>Loop/final for cremonesi with poles outside</i>	50	35x21x17	2,90	3,20	3,45



art. 124
MANO DESTRA



art. 125
MANO DESTRA



art. 404



art. 440



art. 442



art. 443



art. 444

Prezzi in € - Price in €

ART.	DESCRIZIONE	CONF. PEZZI	MISURE MM	OLV	OBG	OL	OBR	OCR	OCS
124	Maniglia a blocco "pesante" dx/sx con incontro <i>Heavy block handle right/left with matching</i>	20				7,65	8,15	9,35	11,10
125	Maniglia a blocco "leggera" dx/sx con incontro <i>Light block handle right/left with matching</i>	20				7,65	8,15	9,35	11,10
404	Moschettone portachiavi <i>Spring catch key-ring</i>	50				4,20	4,60	4,80	
440	Coprichiave "universal" <i>Universal key cover</i>	24		11,90	11,90				
442	Coprichiave "elegant" <i>Elegant key cover</i>	24		11,90	11,90				
443	Chiave "orion" patent <i>"Orion" key patent</i>	24		7,10	7,70				
444	Chiave "riva" patent <i>"Riva" key patent</i>	24		7,10	7,70				



art. 490



ART. 490 A



art. 491



ART. R239

Prezzi in € - Price in €

ART.	DESCRIZIONE	CONF. PEZZI	MISURE MM	OLV	OL	OBR	OCR	OCS	B/INV
490	Nodo per iinferriate liscio - h 60 mm <i>Knot</i>	6	Ø30 foro Ø12	10,80					
		6	Ø30 foro Ø14	10,80					
		6	Ø35 foro Ø16	11,90					
		6	Ø35 foro Ø18	11,90					
490 A	Mezzo nodo per inferriate - h 25 mm <i>Middle terminal knot</i>	20	Ø30 foro Ø12	6,00					
		20	Ø30 foro Ø14	6,00					
		20	Ø35 foro Ø16	6,00					
		20	Ø35 foro Ø18	6,00					
491	Nodo per iinferriate sagomato - h 60 mm <i>Knot</i>	12	Ø30 foro Ø12	10,80					
		12	Ø30 foro Ø14	10,80					
		12	Ø35 foro Ø16	11,90					
		12	Ø35 foro Ø18	11,90					
R239/8124	Rondella per cerniere	100	Øest.12 x 8 x4h	1,05	0,55	0,66	1,05	1,15	1,05
R239/10144		100	Øest.14 x10 x4h	1,05	0,55	0,66	1,05	1,15	1,05
R239/10145		100	Øest.14 x10 x5h	1,05	0,55	0,66	1,05	1,15	1,05
R239/11155		100	Øest.15 x11 x5h	1,05	0,55	0,66	1,05	1,15	1,05
R239/10184		100	Øest.18 x10 x4h	1,20	0,66	0,80	1,20	1,30	1,20
R239/11184		100	Øest.18 x11 x4h	1,20	0,66	0,80	1,20	1,90	1,20

art. B145CP



art. B250CP



art. B350CA



art. B46540



art. B56540



art. B76232



art. B84545



art. B95050



art. B106232AC



art. B1152AC

Prezzi in € - Price in €

ART.	DESCRIZIONE	CONF. PEZZI	MISURE MM	OLV	OBG	B/ANT B/INV	OCR	OCS	OCR/OCS	OLS	INOX SAT
B145CP	Bocchetta coprivite a pressione Ø45 c/ sottoplast. foro patent o/e yale <i>Escutcheon Ø45 cylinder or yale hole</i>	24	Ø45 h7	2,85	3,20	3,20	3,80	3,80			
B250CP	Bocchetta coprivite a pressione Ø45 c/ sottoplast. foro doppia mappa <i>Escutcheon Ø45 double web hole</i>	24	Ø45 h7	3,68	4,15			4,75			
B350CA	Bocchetta coprivite ad avvitare Ø50 foro patent o/e yale <i>Escutcheon Ø50 screw type, screw cover opening patent or yale hole</i>	12	Ø50 h10	7,00	8,10	8,10	8,90	8,90	10,00		
B46540	Bocchetta azzurra ovale foro yale <i>Oval escutcheon with cylinder hole</i>	12	65x40 h10		5,90					5,90	
B56540	Bocchetta sabina ovale foro yale <i>Oval escutcheon with cylinder hole</i>	12	65x40 h10		6,90					6,50	
B76232CP	Bocchetta ovale coprivite a pressione c/sottoplastica foro patent o/e yale <i>Oval escutcheon screw cover with cylinder or yale hole</i>	12	62x32 h10	4,20	4,60	4,60	5,80	5,80			
B84545	Bocchetta quadrata coprivite a pressione c/foro patent o/e yale <i>Square escutcheon with patent or cylinder hole</i>	24	45x45 h10				4,85	4,85			
		24	50x50 h10				5,20	5,20			
B95050	Bocchetta quadrata c/foro patent o/e yale <i>Square escutcheon with patent or yale hole</i>	12	Ø45 h7					9,00	9,00		
B106232AC	Bocchetta ovale coprivite a pressione foro patent o/e yale c/sottoplastica <i>Oval escutcheon screw cover with patent or cylinder hole</i>	12	32x62 h10								4,40
B1152AC	Bocchetta coprivite a pressione Ø52 foro patent o/e yale c/sottoplastica <i>Escutcheon screw cover Ø52 with patent or cylinder hole</i>	12	Ø52 h10								4,40

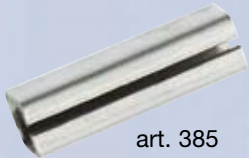

art. 385



art. PF1CF



art. PF2CQ



art. Q8ESP



art. 336



art. 337

Prezzi in € - Price in €

ART.	DESCRIZIONE	CONF. PEZZI	MISURE MM	FERRO ZINCATO		
385	Riduzione da mm 7 a mm 6	100	L 20	0,55		
	Riduzione da mm 8 a mm 6	100	L 15	0,55		
	Riduzione da mm 8 a mm 6	100	L 30	0,55		
	Riduzione da mm 8 a mm 7	100	L 20	0,55		
	Riduzione da mm 8 a mm 7	100	L 30	0,55		
PF1CF	Piastrina di fissaggio ferma pomoli c/filetto 8 mm <i>Spindles for knobs 8 mm</i>	50	MA 8x26	2,60		
PF2CQ	Piastrina di fissaggio c/quadro 8 mm fres. coda rondine <i>Spindle for handles q. 8</i>	50	Q. 8x28	2,60		
Q8ESP	Ferro q.8 Ad espansione per porte blindate <i>Expansion spindle q.8</i>	30	Q.8x55	2,40		
		30	Q.8x65	2,40		
		30	Q.8x80	2,70		
		30	Q.8x90	2,90		
336	Ferro quadro per maniglie <i>Square spindle for handles</i>	100	Q. 6x100	0,95		
		100	Q. 7x70	0,95		
		100	Q. 7x90	0,95		
		100	Q. 7x100	1,70		
		100	Q. 8x90	1,20		
		100	Q. 8x100	1,20		
		100	Q. 8x115	1,40		
		100	Q. 8x140	1,60		
		337.10	Ferro mm. q. 8x100 con niplax mm 10/12/14	30	10 MA	4,70
		337.12	<i>Niplax square spindle mm 8x100</i>	30	12 MA	4,80
337.14		30	14 MA	4,80		



Placca N. 01 SABINA
mm 248x42x9



Placca N. 02 AZZURRA
mm 245x40x9



Placca N. 03 EUROPA
mm 240x38x9



Placca N. 05 MERANO
mm 252x42x9



Placca N. 06 EXPORT
mm 255x41x9



Placca N. 07 VIOLA
mm 246x42x11

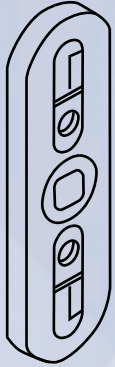

Gioco Gratz

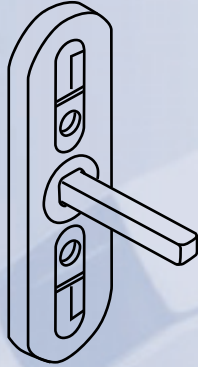

Gioco Gratz + $\sphericalangle 7$



Gioco Gratz perni

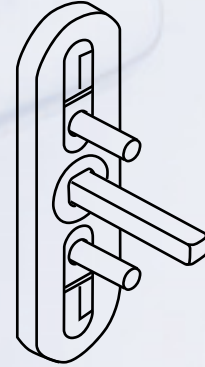

Gioco Gratz perni
perni + $\sphericalangle 7$

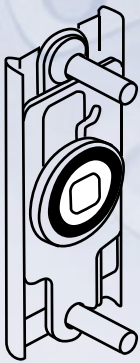

Gioco MP

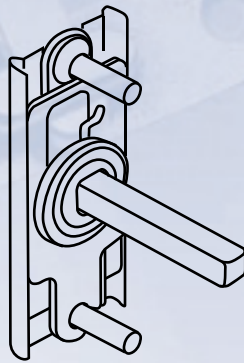

Gioco MP + $\sphericalangle 7$



Gioco Gratz
con bussole

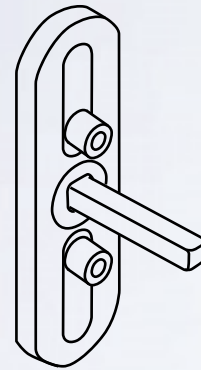

Gioco Gratz
con bussole + $\sphericalangle 7$

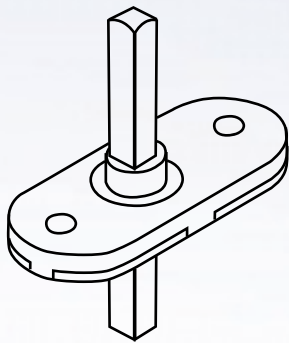

Movimento D.k.

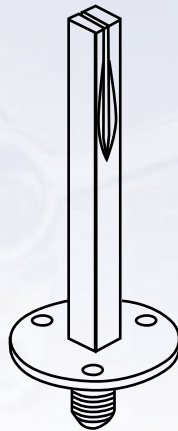

Ferro per maniglia
Pomolo per porte blindate

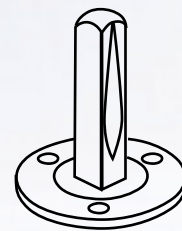

Ferro ferma-pomolo
con quadro
o con filetto



Ferro espansione
per porte blindate



OL
OTTONE LUCIDO
NON VERNICIATO



OLV
OTTONE LUCIDO
VERNICIATO



OLS
OTTONE LUCIDO
SATINATO VERNICIATO



OSV
OTTONE SATINATO
VERNICIATO



OBG
OTTONE BRONZATO
GRAFFIATO

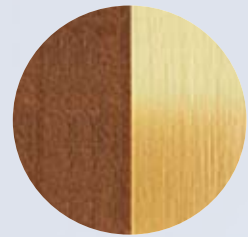

FUME
OTTONE BRONZATO
SFUMATO

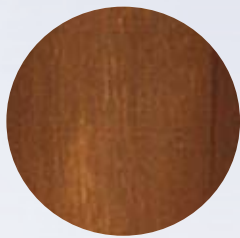

OBR
OTTONE BRONZATO



OBV
OTTONE BRONZATO
VERNICIATO



B/INV
BRONZO INVECCHIATO



B/ANT
BRONZO ANTICO



OCR
OTTONE CROMATO



OCS
OTTONE CROMATO
SATINATO



NIK
OTTONE NICHELATO



NKS
OTTONE NICHELATO
SATINATO

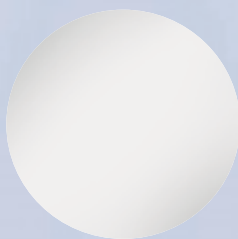

LB
LACCATO BIANCO

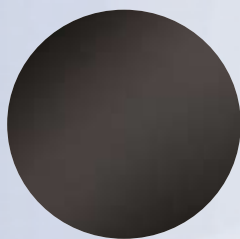

LNO
LACCATO NERO

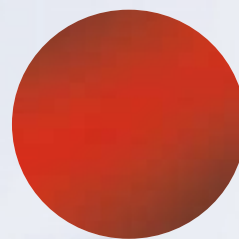

LAC
LACCATO COLORI A SCELTA
ROSSO-GIALLO-BIANCO-NERO



PL0
PLACCATO ORO 24K



PL0/CF
PLACCATO ORO/CROMATO NERO
(CANNA DI FUCILE)



CF
CROMATO NERO



P/BIABLU
PORCELLANA CON
DECORAZIONE BLU



P/CHROSA
PORCELLANA CON
DECORAZIONE ROSA



P/ORO
PORCELLANA CON FILO IN
ORO



P/BIA
PORCELLANA BIANCA



P/CH
PORCELLANA CHAMPAGNE



PVD
ZIRCONIO PVD

MANIGLIA PER PORTA

Dati importantissimi da riportare sempre all'atto della compilazione di una commissione:

- A) Sezione del quadro (vedi figura a lato)
Se da mm 6-7-8 misura standard q 8
- B) Distanza tra foro quadro e foro chiave (interasse) le misure standard italiane sono:
Dist. 70-90-85 Yale mm 70-90 nott. Wc.
Se le maniglie sono richieste su rosetta indicare quale tipo, ed il tipo del foro chiave se patent o yale.
- C) distanza interasse particolari, sono disponibili a richiesta, e.S. Mm 72-75-78 foro chiave normale e mm 70-72-90 ecc. Foro chiave yale.

CREMONESE O MARTELLINA

Nel caso delle finestre specificare se si richiede la cremonese, la martellina tradizionale o la martellina dry keep.

- A) Per la cremonese indicare il tipo di movimento da applicare, es. Gratz c. Fori, c. Bussole, gratz + q7 ecc.
- B) Per martelline indicare se sono con ferro mm q.7 A sfilare, oppure con movimento dry keep ferro q7x42 misura standard o altre misure.

DOOR HANDLE

When compiling an order always include this extremely important information:

- A) Panel section (see figure alongside)
If 6-7-8 mm. Standard q 8
- B) Distance between panel hole and keyhole (inter-axis) the standard italian sizes are:
Dist. 70-90-85 Yale mm. 70-90 Wc pawl.
If the handles are requested on washers indicate the type and the type of key hole if patent or yale.
- C) Special inter-axis distances are available on request, e.G. 72-75-78 Mm. Normal keyhole and 70-72-90 mm. Yale keyhole.

"CREMONESE" OR "MARTELLINA"

In the case of windows, specify if you want the "cremonese" or the traditional "martellina" or the dry keep "martellina".

- A) For the "cremonese" indicate the type of movement to apply, e.G. "Gratz" with holes, with bushings, "gratz" + q7 etc.
- B) For "martelline" indicate if they are with iron mm. Q.7 Slide out or with iron keep dry movement q7 x 42 misure standard, on demand other measure es. 28-32 Ecc.

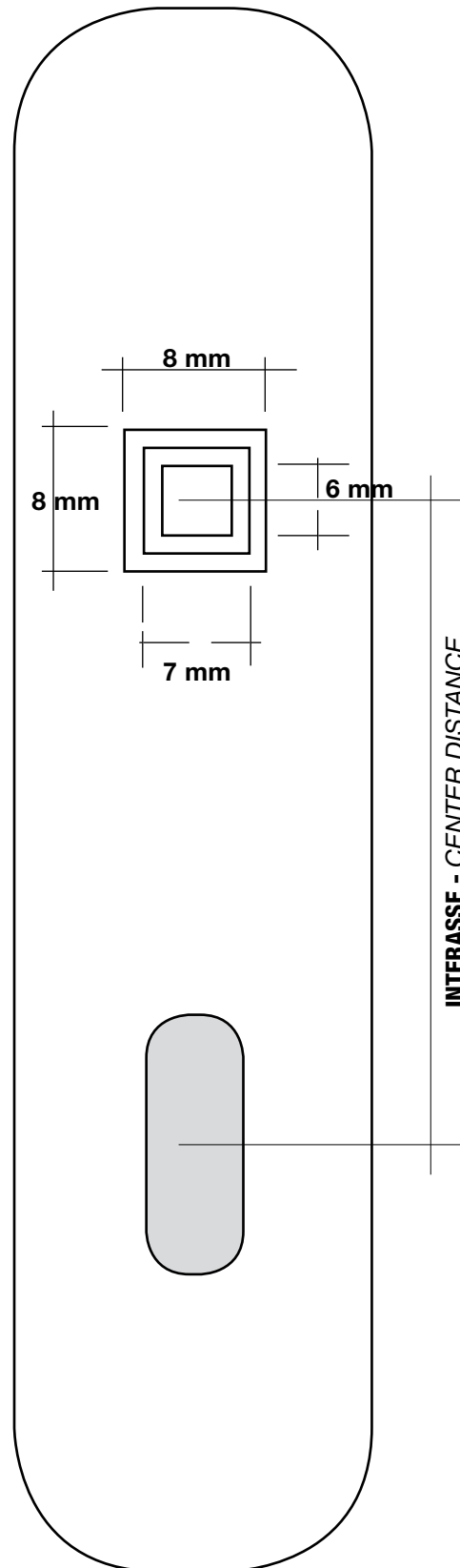

CONDIZIONI GENERALI DI VENDITA

- 1 Tutti i nostri prezzi, salvo differente accordo scritto, si intendono per merce resa franco nostro magazzino in Preseglie, imballi esclusi.
- 2 Le commissioni, comunque assunte, si intendono valide salvo nostra approvazione.
- 3 Tutti i pagamenti devono essere effettuati direttamente alla nostra Sede.
- 4 I termini di consegna, salvo tassativa pattuizione scritta, vanno intesi con ragionevole tolleranza, ed eventuali ritardi non daranno luogo a nessun tipo di indennizzo.
- 5 Ci riserviamo di apportare quelle varianti nei disegni e nei materiali che a nostro giudizio si rendono necessarie.
- 6 La merce viaggia a rischio e pericolo del committente, anche se spedita in Porto Franco Destino.
- 7 Ogni reclamo dovrà essere fatto a mezzo lettera raccomandata entro 8 giorni dal ricevimento della merce, trascorsi i quali, decadrà ogni diritto di reclamo da parte del compratore.
- 8 Per qualsiasi controversia, unico Foro competente è quello di Brescia.
A richiesta possiamo fornire qualsiasi articolo su campione o disegno. Il presente catalogo annulla e sostituisce ogni precedente illustrazione.
- 9 L'importo minimo per ogni commissione dovrà essere di 250,00 EURO IVA esclusa, eventuali ordini di importo inferiore saranno evasi con un addebito di € 12,00 in fattura a parziale copertura delle spese di gestione da noi sostenute. (Minimo d'ordine valido solo per le spedizioni effettuate in Italia).

GENERAL SALE CONDITIONS

- 1 *All our prices, unless otherwise agreed in writing, are stated ex our warehouse in Preseglie, packing excluded.*
- 2 *All orders are accepted subject to our confirmation.*
- 3 *Payments should be made direct to our Head Office in Preseglie.*
- 4 *Terms of delivery, unless otherwise expressly agreed in writing, are not strictly binding.*
- 5 *We reserve the right to make any alterations in designs and materials as we may consider necessary.*
- 6 *Goods are forwarded at the customer's risk.*
- 7 *Claims should be lodged by registered letter, within 8 days from receipt of goods. Any controversy which may arise shall come under the exclusive jurisdiction of Brescia law-Courts.*
- 8 *Upon request we can also supply any kind of article according to your sample or design. This catalogue cancels and replaces any preceding illustrating documentation.*
- 9 *The minimum amount for each order must be at least 250,00 EURO, VAT excluded. Any orders received for lower amounts will be executed with a charge of 12,00 € in the invoice to partially cover our management costs. (Minimum order only valid for shipments made in Italy).*



PRODUZIONE MANIGLIE E ACCESSORI D'ARREDO
HANDLES AND ACCESSORIES PRODUCTION

Via del Sardano, 16 | 25070 PRESEGLIE (Brescia - Italy)
 Tel. +39 0365 860245 | Fax +39 0365 1900092 | info@morettinimaniglie.com | morettinimaniglie@pec.it
www.morettinimaniglie.com